

**VICTOR**  
AN ESAB BRAND



**INDUSTRIAL GAS CUTTING EQUIPMENT**

[esab.com](http://esab.com)





Victor Equipment was founded in 1913 by L.W. Stettner. Stettner, a welder by trade, suffered the loss of an eye from a welding accident and subsequently set out to design and build better, safer welding products. His designs for welding torches, cutting torches & gas regulators were quickly accepted and the original San Francisco-based Victor Oxy-Acetylene Welding Equipment Company grew rapidly. Stettner's "safety oriented" designs resulted in numerous patents and firsts including spiral mixers, gooseneck nozzles, and safety regulators.



In time, the company name was shortened to Victor Equipment Company. Victor's product line and business volume grew steadily and expanded capacity was needed. The original San Francisco manufacturing operations were relocated to new headquarters in Denton, TX in the mid 1960's.

Today, Victor is an ESAB brand, and continues as the world leader in gas and safety regulator equipment, providing superior quality, reliable products and high performance. This is the result of numerous product innovations including patented built in flashback arrestors and check valves for torches.

That line up includes cutting and welding equipment such as oxy-acetylene and oxy-fuel equipment, torch handles, cutting attachments, straight cutting torches, gas regulators, cutting tips, welding nozzles and cutting & welding outfits.

Victor products cover the full range of needs, from general industrial to heavy duty mill and foundry requirements. Victor's gas equipment line is the most complete selection offered from any manufacturer.

ESAB Welding & Cutting Products, established in 1904, is a recognized leader in the welding and cutting industry.

When you choose our products, expect them to offer unparalleled performance, superior productivity and built-to-last dependability in end-user applications such as:

- Automotive
- Construction
- Demolition & Scrap
- Farming & Ranching
- Heavy Equipment Manufacturing
- Fabrication & Manufacturing
- Laboratory & Testing
- Maintenance & Repair
- Manufacturing
- Mechanical Contractors
- Medical
- Metal Art & Jewelry
- Mining & Aggregates
- Oil & Gas
- Pipe & Pipelines
- Shipbuilding
- Training & Education
- Transportation

We strive to deliver the highest level of customer care. ESAB field sales representatives and technical support personnel are dedicated to providing the highest level of customer service and training.

For more information about ESAB, and its leading brands – including Victor, visit [esab.com](http://esab.com) or call 1-800-ESAB123.

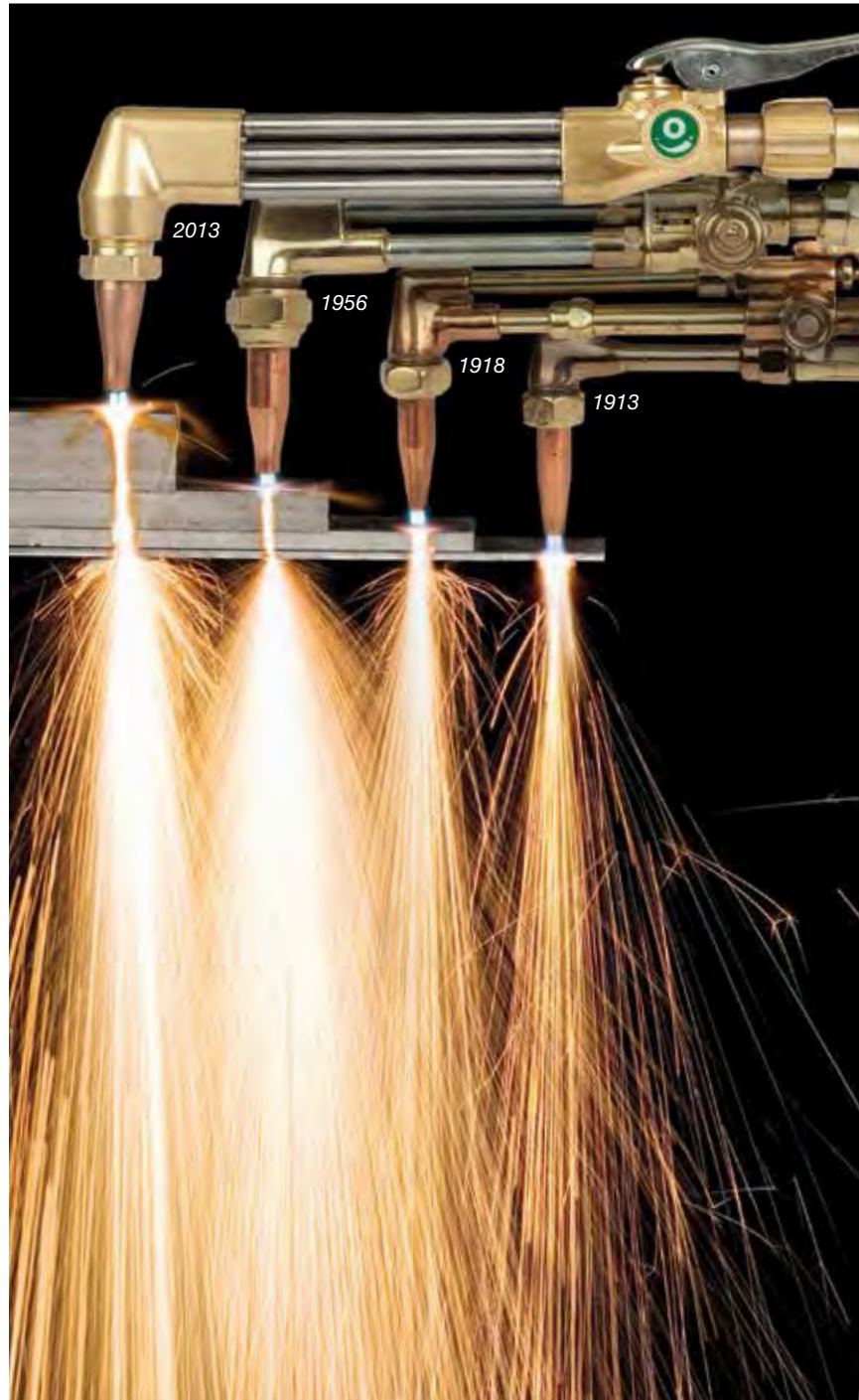

# TABLE OF CONTENTS

## SYSTEMS

Journeyman®	4
Journeyman II	4
Contender®	5
Performer®	5
Medalist® 350	6
Medalist 250	6
Journeyman Select	7
Journeyman 450	7
Cutter™ Select ST 2600FC	8
Cutter Select ST 900FC	8
Portable Tote	9

## REGULATORS

Data Charts	11
Regulator Selection Guide	13
Single Stage Regulators	20
Two Stage Regulators	26
High Pressure / Manifold Regulators	28
Liquid, Line and Station Regulators	30
Pipeline Devices	32
Flow Products	34

## HANDLES & ATTACHMENTS

400 Series	42
300 Series	42
100 Series	44
J Series	44

## WELDING & HEATING NOZZLES/TIPS

Multi-Flame Heating Nozzles	46
Heating Nozzles	47
Welding Nozzles	48

## STRAIGHT TORCHES

## SAFETY ACCESSORIES

## CUTTING TIPS

Series 1 – Cutting Tips	64
Series 3 – Cutting Tips	80
OEM Cutting Tips	83

## MACHINE TORCHES

## COMPRESSED GAS ASSOCIATION (CGA)

Connectors Guide	90
------------------	----

## WARRANTY

*This information is accurate to the best of our knowledge at the time of printing and is subject to change at any time at Victor's sole discretion.*



**1913**

The history of Victor begins in 1913 in San Francisco. The founder of Victor, Mr L.W. Stettner suffered a serious injury. A welder by trade, Stettner lost an eye during a welding accident, and following recovery, he was determined to design safer welding equipment and accessories – the birth of the Victor Torch.



**1941-1945**

Victor torches are integral to the war effort in World War II.



**1918**

The Victor handle was the first to feature a tube within a tube design to create a smaller diameter handle.

Victor was the first to design and invent the cutting attachment which included spiral mixers.

**1940s**

The SR 40 Oxygen Safety Regulator was a single stage reduction regulator. It featured a simplified seat mechanism which eliminated the ball housing.

**1937**

Mayor Angelo Rossi uses a Victor cutting torch to cut the chain opening the Golden Gate Bridge.



VICTOR

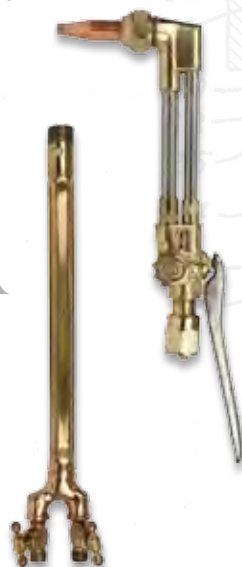

# EVOLUTION. INNOVATION. INSPIRATION.

**1980**

Victor began to manufacture the 315 welding handle with built-in check valves.



**1995**

Victor patents built-in flashback arrestors into their torches for added operator safety.



**2013**

Victor 400 series cutting torches with ergonomic handle and G Series regulators released.



**1966**

Victor Equipment Company moved to Denton, Texas.



**2009**

Victor introduced the EDGE™ regulator changing the landscape of gas regulation.



Victor manufacturing team worked overtime to produce over 5,000 pieces of equipment including special 15 and 20 foot length cutting torches to help with 9/11 clean-up efforts.



**2012**

The Golden Gate Bridge has its 75th Anniversary, Governor Schwarzenegger uses a Victor torch to recreate the original chain cutting ceremony.

**2014**

Victor becomes An ESAB Brand



## JOURNEYMAN®

### HEAVY DUTY

This heavy duty system cuts up to 3/4" (19.1 mm) or 8" (203.2 mm) with optional tips. It welds up to 1/2" (12.7 mm) or 3" (76.2 mm) with optional nozzles.



- ESS4 Series regulators
- H 315FC torch handle with built-in flashback arrestors & check valves
- CA 2460 cutting attachment
- Cutting tip (See chart)
- MFA heating nozzle (See chart)
- Welding nozzles (See chart)
- T-grade hose 20' x 1/4" (6.1 m x 6.4 mm)
- Striker and tip cleaner
- Soft-sided shade 5 goggles



Gas Service	Part No.	Welding Nozzle	Cutting Tip	Heating Nozzle	Oxygen Regulators	Fuel Gas Regulator
Acetylene	0384-2035	(W) 1,3,5	1-1-101	8-MFA	ESS4-125-540	ESS4-15-300
	0384-2036	(W) 1,3,5	1-1-101	8-MFA	ESS4-125-540	ESS4-15-510
British Fuel	0385-0530	(W) 1,3,5	1-1-101	8-MFA	ESS4-125-992	ESS4-15-993

## JOURNEYMAN II

### HEAVY DUTY

This heavy duty system cuts up to 3/4" (19.1 mm) or 8" (203.2 mm) with optional tips. It welds up to 1/8" (3.2 mm) or 3" (76.2 mm) with optional nozzles.



- ESS4 Series regulators
- 315FC torch handle with built-in flashback arrestors & check valves
- CA 2460 cutting attachment
- Cutting tip (See chart)
- Heating nozzle (See chart)
- Welding nozzle (See chart)
- T-grade hose 20' x 1/4" (6.1 m x 6.4 mm)
- Striker and tip cleaner
- Soft-sided shade 5 goggles

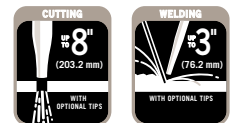

Gas Service	Part No.	Welding Nozzle	Cutting Tip	Heating Nozzle	Oxygen Regulators	Fuel Gas Regulator
Acetylene	0384-2040	(W) 2	1-1-101	-	ESS4-125-540	ESS4-15-300
	0384-2041	(W) 2	1-1-101	-	ESS4-125-540	ESS4-15-510
British Fuel	0385-0531	(W) 2	1-1-101	-	ESS4-125-992	ESS4-15-993
Propane/ Natural Gas	0384-2042	-	1-GPN	8T55	ESS4-125-540	ESS4-125-510LP
Propylene	0384-2043	-	1-GPP	8T55	ESS4-125-540	ESS4-125-510LP



# CONTENDER®

## HEAVY DUTY

This heavy duty system cuts up to 3/4" (19.1 mm) or 8" (203.2 mm) with optional tips. It welds up to 3" (76.2 mm) with optional nozzles on acetylene models.



- ESS3 Series regulators
- 315FC torch handle with built-in flashback arrestors & check valves
- CA 2460 cutting attachment
- Cutting tip (See chart)
- Heating nozzle (See chart)
- T-grade hose 20' x 1/4" (6.1 m x 6.4 mm)
- Striker



Gas Service	Part No.	Welding Nozzle	Cutting Tip	Heating Nozzle	Oxygen Regulators	Fuel Gas Regulator
Acetylene	0384-2051	-	1-1-101	6-MFA	ESS3-125-540	ESS3-15-300
	0384-2050	-	1-1-101	6-MFA	ESS3-125-540	ESS3-15-510
Propane/ Natural Gas	0384-2052	-	1-GPN	8T55	ESS3-125-540	ESS3-40-510LP
Propylene	0384-2053	-	1-GPP	8T55	ESS3-125-540	ESS3-40-510LP

# PERFORMER®

## MEDIUM DUTY

This medium duty outfit cuts up to 1/2" (12.7 mm) or 6" (152.4 mm) with optional tips. It welds up to 1/4" (6.4 mm) or 1.25" (31.8 mm) with optional nozzles.



- ESS3 Series regulators
- 100FC torch handle with built-in flashback arrestors & check valves
- CA 1350 cutting attachment
- Cutting tip (See chart)
- Heating nozzle (See chart)
- Welding nozzle (See chart)
- T-grade hose 12.5' x 3/16" (3.8 m x 4.8 mm)
- Striker and tip cleaner
- Soft-sided shade 5 goggles



Gas Service	Part No.	Welding Nozzle	Cutting Tip	Heating Nozzle	Oxygen Regulators	Fuel Gas Regulator
Acetylene	0384-2046	(W-1) 0	0-3-101	4-MFA-1	ESS3-125-540	ESS3-15-300
	0384-2045	(W-1) 0	0-3-101	4-MFA-1	ESS3-125-540	ESS3-15-510
Propane/ Natural Gas	0384-2047	-	0-3-GPN	6T55-1	ESS3-125-540	ESS3-40-510LP
Propylene	0384-2048	-	0-3-GPP	6T55-1	ESS3-125-540	ESS3-40-510LP

## MEDALIST® 350 SYSTEM

### HEAVY DUTY

This heavy/medium duty system cuts up to 3/4" (19.1 mm) or 6" (152.4 mm) with optional tips. It welds up to 1/8" (3.2 mm) or 3" (76.2 mm) with optional nozzles.



- Heavy duty construction
- G350 Series regulators
- WH411C torch handle with built-in check valves
- CA411-1 cutting attachment
- Welding nozzle (see chart)
- Cutting tip (see chart)
- RM-grade hose 25' x 1/4" (7.6 M x 6.4 mm)
- Striker and soft-sided goggles
- 5 Year warranty



Gas Service	Part No.	Welding Nozzle	Cutting Tip	Heating Nozzle	Oxygen Regulators	Fuel Gas Regulator
Acetylene	0384-2690	2-UM-350	1-1-101	-	G350-150-540	G350-15-510
	0384-2691	2-UM-350	1-1-101	-	G350-150-540	G350-15-300
Propane/ Natural Gas	0384-2692	-	1-GPN	8-MFN	G350-150-540	G350-60-510LP

## MEDALIST 250 SYSTEM

### MEDIUM DUTY

This medium duty system cuts up to 1/2" (12.7 mm) or 5" (127.0 mm) with optional tips. It welds up to 5/64" (2.0 mm) or 1.25" (31.8 mm) with optional nozzles.



- Medium duty construction
- G250 Series regulators
- WH411C torch handle with built-in check valves
- CA411-3 cutting attachment
- Welding nozzle (see chart)
- Cutting tip (see chart)
- RM-grade hose 20' x 3/16" (6.1 M x 4.8 mm)
- Striker and soft-sided goggles
- 5 Year warranty



Gas Service	Part No.	Welding Nozzle	Cutting Tip	Heating Nozzle	Oxygen Regulators	Fuel Gas Regulator
Acetylene	0384-2540	0-UM-250	0-3-101	-	G250-150-540	G250-15-510
	0384-2541	0-UM-250	0-3-101	-	G250-150-540	G250-15-300
Propane/ Natural Gas	0384-2544	-	1-3-GPN	6-MFN-1	G250-150-540	G250-60-510LP
Propylene	0384-2545	-	1-3-GPP	6-MFN-1	G250-150-540	G250-60-510LP

# JOURNEYMAN SELECT

## HEAVY DUTY

This heavy duty system cuts up to 8" (203.2 mm) and welds up to 3" (76.2 mm) with accessories.



- 315FC torch handle with built-in flashback arrestors & check valves
- CA 2460 cutting attachment
- ESS4 Series regulators
- Available with 75° or 90° head angle



Gas Service	Part No.	Cutting Attachment	Head Angle	Oxygen Regulators	Fuel Gas Regulator
Acetylene	0384-2070	CA 2460	90°	ESS4-125-540	ESS4-15-300
	0384-2068	CA 2460	90°	ESS4-125-540	ESS4-15-510
	0384-2069	CA 2461	75°	ESS4-125-540	ESS4-15-510
British Fuel	0384-2071	CA 2460	90°	ESS4-125-992	ESS4-15-993
	0384-2073	CA 2460	90°	ESS4-125-540	**
Oxygen	0384-2074	CA 2460	90°	ESS4-125-992	**
	0384-2075	CA 2460	90°	ESS4-125-540	ESS4-125-510LP

\*\*Supplied with 2 oxygen regulators

# JOURNEYMAN 450

## HEAVY DUTY

This heavy duty system cuts up to 3/4" (19.1 mm) or 8" (203.2 mm) with optional tips. It welds up to 1/2" (12.7 mm) or 3" (76.2 mm) with optional nozzles.



- SR Series regulators
- 315FC torch handle with built-in flash back arrestors & check valves
- CA2460 cutting attachment
- Cutting tips
- Welding nozzle



Gas Service	Part No.	Welding Nozzle	Cutting Tip	Heating Nozzle	Oxygen Regulators	Fuel Gas Regulator
Acetylene	0384-0807	W-2	1-101	-	SR450	SR460-510
	0384-0808	W-2	1-101	-	SR450	SR460-300
Oxygen	0384-0806	W-2	1-101	-	SR450-540	**

\*\*Supplied with 2 oxygen regulators

## CUTTER™ SELECT ST 2600FC

### HEAVY DUTY

This heavy duty system cuts up to 8" (203.2 mm) with accessories.



- ST 2600FC cutting torch with built-in flashback arrestors and check valves
- ESS4 Series regulators
- Available with 90° head angle



Gas Service	Part No.	Torch	Head Angle°	Oxygen Regulators	Fuel Gas Regulator
Acetylene	0384-2061	ST 2600FC 21"	90°	ESS4-125-540	ESS4-15-300
	0384-2060	ST 2600FC 21"	90°	ESS4-125-540	ESS4-15-510
Propane/ Natural Gas	0384-2062	ST 2600FC 21"	90°	ESS4-125-540	ESS4-40-510LP

## CUTTER SELECT ST 900FC

### HEAVY DUTY

This heavy duty system cuts up to 5" (127.0 mm) with accessories.



- ST 900FC cutting torch with built-in flashback arrestors and check valves
- CSR 350 or ESS3 Series regulators
- Available with a 90° head angle



Gas Service	Part No.	Torch	Head Angle°	Oxygen Regulators	Fuel Gas Regulator
Acetylene	0384-2675	ST 900FC 21"	90°	ESS3-125-540	ESS3-15-300
	0384-0854	ST 900FC 21"	90°	CSR 350D-540	CSR 360A-300
	0384-0853	ST 900FC 21"	90°	CSR 350D-540	CSR 360A-510
Propane/ Natural Gas/ Propylene	0384-2677	ST 900FC 21"	-	ESS3-125-540	ESS3-40-510LP

## CUTTER™ ST 400C

### EXTRA HEAVY DUTY

This heavy duty system cuts up to 12" (300.0 mm) with optional accessories.

- Extra heavy duty
- Heavy fabrication, oil & gas, demolition & recycling
- Built-in Check Valves
- Precision balanced for operator comfort
- G350 Series regulators
- 5 Year warranty



Gas Service	Part No.	Torch	Head Angle°	Cutting Tip	Oxygen Regulators	Fuel Gas Regulator
Acetylene	0384-2694	ST400C 21"	90°	2-1-101	G350-150-540	G350-15-510
	0384-2695	ST400C 21"	90°	2-1-101	G350-150-540	G350-15-300

## THE PORTABLE TORCH

### MEDIUM DUTY

This medium duty portable system cuts up to 1/2" (12.7 mm) or 4" (101.6 mm) with optional tips. It welds up to 1/4" (6.4 mm) or 1.25" (31.8 mm) with optional nozzles.

- CSR 150 Series regulators
- 100FC torch handle with built-in flashback arrestors and check valves
- CA 1350 cutting attachment
- Welding nozzle (See chart)
- Cutting tip (See chart)
- T-grade hose 10' x 3/16" (3.1 m x 4.8 mm)
- Striker and goggles



### OPTIONAL

- 10 cu ft CGA 200 acetylene cylinder
- 20 cu ft CGA 540 oxygen cylinder



Gas Service	Part No.	Welding Nozzle	Cutting Tip	Cylinders	Oxygen Regulators	Fuel Gas Regulator
Acetylene	0384-0935	(W-1) 1	0-3-101	No	CSR 150CR-540	CSR 160AR (MC)
	0384-0936	(W-1) 1	0-3-101	Yes	CSR 150CR-540	CSR 160AR (MC)

## PORTABLE TOTE

### MEDIUM DUTY

This medium duty portable system has a rugged patented design with a molded plastic carrying case and cuts up to 1.25" (31.8 mm) or welds up to 3/32" (2.4 mm).



- D 150 CR regulator
- D 160 AR regulator
- WH 270FC-V welding torch with built-in flashback arrestors and check valves
- CA 270-V cutting attachment
- Welding nozzle (See chart)
- Cutting tip (See chart)
- Twin RM-grade hose 12.5' x 3/16" (3.81 m x 4.8 mm)

### OPTIONAL

- 10 cu ft CGA 200 acetylene cylinder
- 20 cu ft CGA 540 oxygen cylinder



Gas Service	Part No.	Welding Nozzle	Cutting Tip	Cylinders	Oxygen Regulators	Fuel Gas Regulator
Acetylene	0384-0938	2-UM-1	0-3-101	No	FPR 150CR-540	FPR 160AR-200
	0384-0939	2-UM-1	0-3-101	Yes	FPR 150CR-540	FPR 160AR-200

## POWDER SPRAY TORCH KIT

The Victor VPT-100 provides powder feed into the gas mixture. Deposit thickness is controlled by the powder flow rate of the torch.



- 100 FC Torch Handle
- TE tips: size 3, 4
- TEMF tip: size 6
- 1 lb of Tungsten Carbide #600
- 1 lb of Nickel base #22
- Elbow assembly
- Hopper assembly

Model No.	Part No.	Description
VPT-100	0384-1265	Powder Spray Torch Kit

## FIRE-STICK

### TORCH KIT

- Two models available - with or without regulator
- For propane (hose approved for LP)



Model No.	Part No.	Description	BTU's
HS-101	0384-1251	Fire-Stick with R-LP Regulator	350,000
HT-500	0384-1261	Fire-Stick without Regulator (Heavy Duty)	500,000

## MODEL NUMBERING EXPLANATION

Single or Two Stage model designations as well as those identifying delivery range are common to all regulators unless otherwise noted on individual ordering charts. When ordering be certain to specify delivery range, CGA inlet connections, and regulator part number.

### REGULATOR ORDERING MATRIX

XX		XXX		X	XXX				
Single Stage Model		Series		Delivery Range		CGA Connection*			
SR	Single Stage	150	Light Duty	A	2-15 psig	CGA 200	Acetylene (MC)	CGA 580	Nitrogen, Argon, Helium
HSR	Single Stage with Flow Meter	250	Medium Duty	B	2-40 psig	CGA 300	Acetylene (Commercial)	CGA 590	Air (Industrial)
VTS	Two Stage Design	350	Heavy Duty	C	4-80 psig	CGA 320	Carbon Dioxide	CGA 660	Corrosive
HVTS	Two Stage with Flow Meter	450	Extra Heavy Duty	D	5-125 psig	CGA 326	Nitrous Oxide	CGA 677	Nitrogen, Argon & Helium
AR	Air Relieving			E	10-200 psig	CGA 346	Air (Formerly 1340)	CGA 680	Nitrogen, Argon
S	Station			F	50-750 psig	CGA 347	Air	CGA 701	Oxygen
L	Line			G	100-1500 psig	CGA 350	Fuel Gas, Hydrogen	CGA 992	British Oxygen & Inert Gas
HRF	Single Stage w/ Internal Flow Meter			J	200-3000 psig	CGA 500	Medical Mixtures	CGA 993	British Fuel Gas
AF	Argon Flow Gauge			K	300-4500 psig	CGA 510	Acetylene (POL)	CGA 996	Manifold Oxygen & Inert Gas
CF	CO2 Flow Gauge					CGA 510LP	Propane, Natural Gas, Propylene	CGA 997	Manifold Fuel Gas
DL	Dome Loaded					CGA 520	Acetylene (B)	CGA 024	Station Oxygen
BSL	Bulk System Line					CGA 540	Oxygen	CGA 025	Station Fuel Gas
DFM	Dual Flow Meter					CGA 555	Propane, Butane	CGA 034	Station Inert Gas
						CGA 577	Oxygen		

### ORDERING EXAMPLE:

#### SR-250-D-540

Single Stage, 250 Series, with 5-125 Delivery Range, for Oxygen Service CGA 540 Inlet

### EDGE SERIES REGULATOR ORDERING MATRIX

X		XX		X	XXX		XXX		XX		
Series		Type		Capacity		Max Delivery Pressure		CGA Connection*		Suffix	
E	Edge Series	SS	Single Stage, Side Inlet	7	High Flow					R	Rear Entry
		LC	Liquid Cylinder	4	High Capacity	15, 40, 80, 125, 200, 750,		*Same as above Chart		A	Acetylene
		ST	Station	3	Medium Capacity	1500, 3000, 4500			F	Fuel Gas	
		SL	Line						X	Oxygen	
		TS	Two Stage						LP	Liquified Petroleum	

### ORDERING EXAMPLE:

#### ESS4-125-510LP

Edge Series Single Stage, High Capacity w/ up to 125 Delivery Range, for Liquid Petroleum Service CGA 510 Inlet

### REGULATOR DELIVERY RANGES

A	2-15 psig	F	50-750 psig
B	2-40 psig	G	100-1500 psig
C	4-80 psig	J	200-3000 psig
D	5-125 psig	K	300-4500 psig
E	10-200 psig		

Outlet pressure delivery ranges are not minimum or maximum outlet pressure limits. Regulators can be adjusted to zero psig outlet pressure and generally, to pressures in excess of those specified. The use of these regulators to control pressures outside of the specified ranges is not recommended.

### REGULATOR GAUGES

A Range	2-30 psig	F Range	50-1000 psig
B Range	2-60 psig	G Range	100-2000 psig
C Range	4-100 psig	J Range	200-4000 psig
D Range	5-200 psig	K Range	200-6000 psig
E Range	10-400 psig		

When ordering regulators, specify part numbers. Regulators should not be used as a shut-off valve nor should they be used to protect downstream equipment. Unless otherwise noted, high pressure gauges for all oxygen, inert gas, CO<sub>2</sub> and N<sub>2</sub>O, and hydrogen models are graduated 200-4000 psig. High pressure gauges for fuel gas models are graduated 10-400 psig. Low pressure or outlet gauge ranges are determined by the regulator delivery range selected.

## HOW TO READ THE FLOW DATA CHARTS:

The regulator flow data is provided to assist in determining the proper regulator for the required application. The data is given for reference purposes only. If additional information is necessary contact your local distributor or the Customer Service Department at 1-800-426-1888

The regulator flow data was established by connecting a valve to the regulator outlet. The valve was opened and the flow rates measured. The amount of pressure drop is shown on the curves as the flow increases.

### EXAMPLE

An SR 450D with an inlet of 2000 psig and an internal pressure setting of 125 psig (no flow) will flow 1000 SCFH, but the delivery pressure will drop to 115 lb As the flow increased to 2000 SCFH, the pressure will drop to 108 psig.

With an inlet pressure of 200 psig and an initial setting of 125 psig, the regulator will flow 1000 SCFH with a pressure drop to 98 psig. At 2000 SCFH flow, the pressure will drop to 78 psig. If a delivery pressure other than the ones shown on the flow charts is required, use an average curve rate between the upper and lower pressures shown.

### FLOW (SCFH)

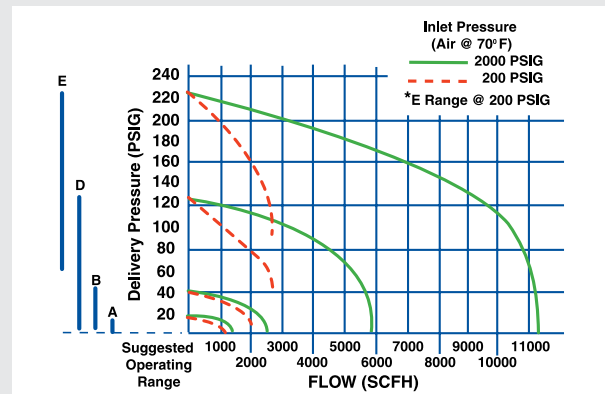

### DELIVERY PRESSURE RISE

Single stage regulators have an increase in delivery pressure as the cylinder pressure decreases. Listed below is the amount of pressure increase per 100 psig decrease in cylinder (inlet) pressure.

ESS7-125	.95 psig
ESS7-200	1.54 psig
ESS4-125-540	.59 psig
ESS3-125-540	.53 psig
SR 4 Series	J & K Range 4.8 psig
SR 5 Series	1.0 psig
SR 250 Series	0.5 psig
SR 350 Series	0.8 psig
SR 450 Series	0.6 psig
SR 600 Series	0.58 psig
SR 700 Series	1.2 psig

The change in delivery pressure of a Two Stage regulator from full to empty Cylinder (inlet pressure) is negligible.

### FOR CONVERSION TO OTHER GASES

All flow capacity information is given in SCFH of free air (1.00). For conversion to other gases multiply the air flow by the correction factor listed below.

Acetylene	1.05
Argon	0.85
Carbon Dioxide	0.81
Helium	2.69
Hydrogen	3.79
Mapp®	0.82
Natural Gas	1.28
Nitrogen	1.02
Oxygen	0.95
Propane	0.80

## PRESSURE DROP REFERENCE CHARTS

### OXYGEN HOSE

Delivery Pressure Pounds Per Square Inch	Oxygen Flow SCFH	Pressure Drop Pound Per Square Inch															
		Hose Length in Feet															
		3/16" Hose				1/4" Hose				5/16" Hose				3/8" Hose			
		12.5	25	50	100	12.5	25	50	100	12.5	25	50	100	12.5	25	50	100
10	100	5.0	6.3							*	*	*	2.3	*	*	*	2.0
	250					9.4				2.7	4.1	5.9		*	*	3.3	6.4
25	100	3.6	5.7	8.2	13.4	*	*	2.9	4.3	*	*	*	*	*	*	*	*
	250	13.2	18.3			6.3	7.9	11.7	16.8	*	2.4	3.2	6.7	*	*	*	3.7
	500					21.5				6.3	8.7	12.1	19.9	2.7	4.6	6.9	11.9
50	100	2.0	3.4	5.9	9.3	*	*	2.0	2.7	*	*	*	*	*	*	*	*
	250	8.0	12.6	19.4		2.7	5.0	7.9	11.0	*	*	2.2	3.9	*	*	*	2.6
	500					14.1	18.2			3.4	5.9	7.7	13.3	*	2.9	4.7	8.0
	750									8.8	12.3	17.8		3.8	6.0	9.8	10.9
75	100	*	2.6	3.8	7.1	*	*	*	2.8	*	*	*	*	*	*	*	*
	250	6.0	9.4	13.3	23.1	3.0	3.8	6.0	8.2	*	*	*	2.8	*	*	*	2.0
	500	19.7				10.7	13.8	19.8		2.5	3.9	6.3	9.4		2.0	3.4	5.9
	750					22.5				6.6	8.8	13.7	18.8	2.7	4.1	7.0	12.2
1000	100	*	*	2.7	4	*	*	*	*	*	*	*	*	*	*	*	*
	250	4.7	6.7	10.3	16.9	2.2	2.8	4.3	6.0	*	*	*	2.2	*	*	*	*
	500	14.1	21.0			8.1	10.8	15.0	21.2	2.0	2.9	4.4	7.1	*	*	2.1	4.6
	750					17.7	23.0	32.3	42.8	4.7	6.9	10.3	15.4	*	2.9	4.9	8.7
	1000					31.0	37.0	53.0	68.5	8.6	11.8	17.4		3.1	5.2	8.8	14.4
	1500					65.5	82.0			19.1				7.7	11.8	19.4	

REGULATORS

### ACETYLENE HOSE

Delivery Pressure Pounds Per Square Inch	Acetylene Flow SCFH	Pressure Drop Pound Per Square Inch															
		Hose Length in Feet															
		3/16" Hose				1/4" Hose				5/16" Hose				3/8" Hose			
		12.5	25	50	100	12.5	25	50	100	12.5	25	50	100	12.5	25	50	100
5	25	0.3	0.5	1.0	1.8	**	**	0.5	0.8	**	**	**	0.3	**	**	**	**
	50	1.2	2.0	3.2		0.5	0.9	1.3	2.4	**	0.3	0.4	0.7	**	**	0.3	0.4
	75	2.6	3.9			1.2	1.8	2.6	4.5	0.4	0.5	0.8	1.4	**	0.3	0.5	0.8
	100	4.3				1.9	2.8	4.4		0.5	0.8	1.3	2.4	0.3	0.4	0.7	1.1
	150					4.0				1.2	1.7	2.7	4.8	0.5	0.8	1.2	2.2
10	25	0.3	0.5	0.8	1.4	**	**	0.3	0.7	**	**	**	**	**	**	**	**
	50	0.9	1.6	2.5	4.9	0.5	0.7	1.1	2.0	**	**	0.3	0.6	**	**	**	0.3
	75	2.0	3.1	6.3		0.9	1.4	2.2	3.7	0.3	0.4	0.5	0.6	**	**	0.3	0.6
	100	4.5	5.4			1.6	2.0	3.6	6.0	0.4	0.6	0.9	2.2	**	0.3	0.5	1.9
	150	7.0				3.2	4.5	7.3		0.9	1.3	2.1	3.9	0.4	0.6	1.0	2.5
	250					8.1				2.3	3.5	5.2	9.8	0.9	1.4	2.5	4.4
14	25	**	0.4		1.3	**	**	0.3	0.6	**	**	**	**	**	**	**	**
	50	0.8	1.4		4.6	0.4	0.6	0.9	1.6	**	**	**	0.4	**	**	**	0.3
	75	1.9	2.9		10.0	0.8	1.2	1.9	3.0	**	0.3	0.5	1.0	**	**	0.3	0.5
	100	3.5	5.1			1.4	2.0	3.0	4.7	0.3	0.6	0.7	1.7	**	0.3	0.4	0.8
	150	7.9				2.9	4.0	6.0	8.7	0.8	1.2	1.7	3.4	0.3	0.5	0.9	1.6
	250					7.4	9.5			2.0	3.1	4.5	8.1	0.7	1.2	2.3	3.8
500									8.7	10.5	13.7		2.9	4.0	8.1	11.5	

\*Indicates pressure drop of less than 2.0 per sq. in.

\*\*Indicates pressure drop of less than 0.2 per sq. in.

To obtain the recommended inlet pressure at the equipment, add the pressure drop figure (shown above) to the delivery pressure at the regulator. Do not exceed 15 psig for acetylene.



# REGULATOR SELECTION GUIDE - BY GAS SERVICE

## OXYGEN

Description	Model	Part Number	Delivery Range (psig)	Gauge Range Inlet	Gauge Range Outlet	CGA Inlet Connection	Outlet Connection	Max Inlet Pressure (psig)	Page Number
ESS7 High Capacity Single Stage	ESS7-125-540	0781-5181	5-125	4000	200	540	7/8" – 14 M RH	3000	20
ESS7 High Capacity Single Stage	ESS7-200-540	0781-5183	10-200	4000	400	540	7/8" – 14 M RH	3000	20
ESS4 High Capacity Single Stage	ESS4-40-540	0781-5154	2-40	4000	60	540	9/16" – 18 M RH	3000	21
ESS4 High Capacity Single Stage	ESS4-125-540	0781-5127	5-125	4000	200	540	9/16" – 18 M RH	3000	21
ESS4 High Capacity Single Stage	ESS4-200-540	0781-5131	10-200	4000	400	540	9/16" – 18 M RH	3000	21
ESS3 Medium Capacity Single Stage	ESS3-125-540	0781-5100	5-125	4000	200	540	9/16" – 18 M RH	3000	21
SR 450 Heavy Duty Single Stage	SR-450D-540	0781-0527	5-125	4000	200	540	9/16" – 18 M RH	3000	22
SR 350 Heavy/Medium Single Stage	SR-350D-540	0781-2341	5-125	4000	200	540	9/16" – 18 M RH	3000	23
VTS 700 Extra Heavy Duty Two Stage	VTS700E-540	0780-0939	10-200	4000	400	540	9/16" – 18 M RH	3000	24
ETS4 High Capacity Two Stage	ETS4-40-540	0781-5217	2-40	4000	60	540	9/16" – 18 M RH	3000	25
ETS4 High Capacity Two Stage	ETS4-125-540	0781-5218	5-125	4000	200	540	9/16" – 18 M RH	3000	25
ETS4 High Capacity Two Stage	ETS4-200-540	0781-5219	10-200	4000	400	540	9/16" – 18 M RH	3000	25
VTS 250 Medium Duty Two Stage	VTS250A-540	0781-3503	2-15	4000	30	540	9/16" – 18 M RH	3000	25
VTS 250 Medium Duty Two Stage	VTS250B-540	0781-3504	2-40	4000	60	540	9/16" – 18 M RH	3000	25
VTS 250 Medium Duty Two Stage	VTS250C-540	0781-3505	4-80	4000	100	540	9/16" – 18 M RH	3000	25
VTS 250 Medium Duty Two Stage	VTS250D-540	0781-3506	5-125	4000	200	540	9/16" – 18 M RH	3000	25
SR 4 High Pressure	SR4F-540	0781-1405	30-750	4000	1000	540	1/4" Swaglok®	3000	26
SR 4 High Pressure	SR4G-540	0781-1425	100-1500	4000	2000	540	1/4" Swaglok®	3000	26
SR 4 High Pressure	SR4J-540	0781-1445	200-3000	4000	4000	540	1/4" Swaglok®	3000	26
SR 600 High Pressure	SR600-550-540	0781-1610	5-550	6000	1000	540	1/4" Swaglok®	3000	27
ELC4 High Capacity Liquid Cylinder	ELC4-125-540R	0781-5199	5-125	--	200	540	9/16" – 18 M RH	3000	28
ESL4 High Capacity Line	ESL4-125-250	0781-5190	5-125	--	200	1/4" NPT	1/4" NPT F	3000	29
EST4 High Capacity Station	EST4-40-024	0781-5191	2-40	--	60	024	9/16" – 18 M RH	200	29
EST4 High Capacity Station	EST4-40-024R	0781-5204	2-40	--	60	024	9/16" – 18 M RH	200	29
EST4 High Capacity Station	EST4-80-024	0781-5192	4-80	--	100	024	9/16" – 18 M RH	200	29
EST4 High Capacity Station	EST4-80-024R	0781-5205	4-80	--	100	024	9/16" – 18 M RH	200	29
EST4 High Capacity Station	EST4-125-024	0781-5193	5-125	--	200	024	9/16" – 18 M RH	200	29
EST4 High Capacity Station	EST4-125-024R	0781-5206	5-125	--	200	024	9/16" – 18 M RH	200	29
L700 High Flow Line	L700C-500	0780-1229	4-80	--	100	1/2" NPT F	1/2" NPT F	350	30
L700 High Flow Line	L700C-750	0780-1220	4-80	--	100	3/4" NPT F	3/4" NPT F	350	30
L700 High Flow Line	L700D-500	0780-1207	5-125	--	200	1/2" NPT F	1/2" NPT F	350	30
L700 High Flow Line	L700D-500PMT	0780-1236	5-125	--	200	1/2" NPT F	1/2" NPT F	350	30
L700 High Flow Line	L700D-750	0780-1209	5-125	--	200	3/4" NPT F	3/4" NPT F	350	30
L700 High Flow Line	L700E-500	0780-1221	10-200	--	400	1/2" NPT F	1/2" NPT F	350	30
L700 High Flow Line	L700E-750	0780-1222	10-200	--	400	3/4" NPT F	3/4" NPT F	350	30
DL700 Dome Load	DL700	0780-1188	5-125	--	--	1/2" NPT F	1/2" NPT F	500	31
BSL Bulk System Line	BSL700	0780-1200	10-200	--	400	1/2" NPT F	1/2" NPT F	350	31

## REGULATOR SELECTION GUIDE - BY GAS SERVICE

### ACETYLENE

Description	Model	Part Number	Delivery Range (psig)	Gauge Range Inlet	Gauge Range Outlet	CGA Inlet Connection	Outlet Connection	Max Inlet Pressure (psig)	Page Number
ESS7 High Capacity Single Stage	ESS7-15-510	0781-5187	2-15	400	30	510	7/8" – 14 LH	3000	20
ESS7 High Capacity Single Stage	ESS7-200-350	0781-5186	10-200	4000	400	350	7/8" – 14 M LH	3000	20
ESS4 High Capacity Single Stage	ESS4-15-300	0781-5133	2-15	400	30	300	9/16" – 18 M LH	3000	21
ESS4 High Capacity Single Stage	ESS4-15-410	0781-4140	2-15	400	30	410	9/16" – 18 M LH	3000	21
ESS4 High Capacity Single Stage	ESS4-15-510	0781-5132	2-15	400	30	510	9/16" – 18 M LH	3000	21
ESS4 High Capacity Single Stage	ESS4-15-993	0781-5134	2-15	400	30	993	9/16" – 18 M LH	3000	21
ESS4 High Capacity Single Stage	ESS4-15-510	0781-5150	2-15	400	30	510	9/16" – 18 M LH	3000	21
ESS3 Medium Capacity Single Stage	ESS3-15-300	0781-5106	2-15	400	30	300	9/16" – 18 M LH	3000	21
ESS3 Medium Capacity Single Stage	ESS3-15-510	0781-5105	2-15	400	30	510	9/16" – 18 M LH	3000	21
SR 450 Heavy Duty Single Stage	SR460A-300	0781-0583	2-15	400	30	300	9/16" – 18 M LH	3000	22
SR 450 Heavy Duty Single Stage	SR460A-510	0781-0584	2-15	400	30	510	9/16" – 18 M LH	3000	22
SR 350 Heavy/Medium Single Stage	SR360A-300	0781-2400	2-15	400	30	300	9/16" – 18 M LH	3000	23
SR 350 Heavy/Medium Single Stage	SR360A-510	0781-2401	2-15	400	30	510	9/16" – 18 M LH	3000	23
SR 250 Medium Duty Single Stage	SR260A-300	0781-0085	2-15	400	30	300	9/16" – 18 M LH	3000	23
SR 250 Medium Duty Single Stage	SR260A-510	0781-0087	2-15	400	30	510	9/16" – 18 M LH	3000	23
VTS 700 Extra Heavy Duty Two Stage	VTS710A-510	0780-0984	2-15	400	30	510	7/8" – 14 M LH	3000	24
ETS4 High Capacity Two Stage	ETS4-15-300	0781-5229	2-15	400	30	300	9/16" – 18 M LH	3000	29
ETS4 High Capacity Two Stage	ETS4-15-510	0781-5230	2-15	400	30	510	9/16" – 18 M LH	3000	29
ETS4 High Capacity Two Stage	ETS4-15-993	07815-2122	2-15	400	30	993	9/16" – 18 M LH	3000	29
VTS 250 Medium Duty Two Stage	VTS260A-300	0781-3583	2-15	400	30	300	9/16" – 18 M LH	3000	25
VTS 250 Medium Duty Two Stage	VTS260A-510	0781-3484	2-15	400	30	300	9/16" – 18 M LH	3000	25
ESL4 High Capacity Line	ESL4-15-250A	0781-5208	2-15	--	30	1/4" NPT F	1/4" NPT F	350	29
EST4 High Capacity Station	EST4-15-025	0781-5194	2-15	--	30	025	9/16" – 18 M LH	200	29
EST4 High Capacity Station	EST4-15-025R	0781-5209	2-15	--	30	025	9/16" – 18 M LH	200	29
L700 High Flow Line	L710A-500	0780-1233	2-15	--	30	1/2" NPT F	1/2" NPT F	350	30
L700 High Flow Line	L710A-750	0780-1201	2-15	--	30	3/4" NPT F	3/4" NPT F	350	30

REGULATORS

### EDGE SERIES COLOR CODING BY GAS TYPE



# REGULATOR SELECTION GUIDE - BY GAS SERVICE

## AIR

Description	Model	Part Number	Delivery Range (psig)	Gauge Range Inlet	Gauge Range Outlet	CGA Inlet Connection	Outlet Connection	Max Inlet Pressure (psig)	Page Number
ESS4 High Capacity Single Stage	ESS4-125-346	0781-5142	5-125	4000	200	346	5/8" - 18 F LH	3000	21
ESS4 High Capacity Single Stage	ESS4-200-346	0781-5145	10-200	4000	400	346	5/8" - 18 F LH	3000	21
ESS3 Medium Capacity Single Stage	ESS3-125-346	0781-5115	5-125	4000	200	346	5/8" - 18 F LH	3000	21
SR 450 Heavy Duty Single Stage	SR450D-346	0781-0532	5-125	4000	200	346	5/8" - 18 F LH	3000	22
ETS4 High Capacity Two Stage	ETS4-125-346	0781-5231	5-125	4000	200	346	5/8" - 18 F LH	3000	29
ETS4 High Capacity Two Stage	ETS4-200-346	0781-5232	10-200	4000	400	346	5/8" - 18 F LH	3000	29
ETS4 High Capacity Two Stage	ETS4-125-590	0781-5224	5-125	4000	200	346	5/8" - 18 F LH	3000	29
VTS 250 Medium Duty Two Stage	VTS250C-346	0781-3510	4-80	4000	100	346	5/8" - 18 F LH	3000	25
VTS 250 Medium Duty Two Stage	VTS250D-346	0781-3512	5-125	4000	200	346	5/8" - 18 F LH	3000	25
SR 4 High Pressure	SR4F-347	0781-1403	50-750	6000	1000	347	1/4" Swagelok®	5500	26
SR 4 High Pressure	SR4G-346	0781-1422	100-1500	4000	2000	346	1/4" Swagelok	3000	26
SR 4 High Pressure	SR4J-346	0781-1442	200-3000	4000	4000	346	1/4" Swagelok	3000	26
SR 4 High Pressure	SR4K-347	0781-1463	300-4500	6000	6000	347	1/4" Swagelok	5500	26
SR 600 High Pressure	SR600-350-347	0781-1605	5-350	6000	600	347	1/4" Swagelok	5500	27
ESL4 High Capacity Line	ELS4-125-250	0781-5190	5-125	--	200	1/4" NPT F	1/4" NPT F	3000	29
L700 High Flow Line	L700C-500	0780-1229	4-80	--	100	1/2" NPT F	1/2" NPT F	350	30
L700 High Flow Line	L700C-750	0780-1220	4-80	--	100	3/4" NPT F	3/4" NPT F	350	30
L700 High Flow Line	L700D-500	0780-1207	5-125	--	200	1/2" NPT F	1/2" NPT F	350	30
L700 High Flow Line	L700D-500PMT	0780-1236	5-125	--	200	1/2" NPT F	1/2" NPT F	350	30
L700 High Flow Line	L700D-750	0780-1209	5-125	--	200	3/4" NPT F	3/4" NPT F	350	30
L700 High Flow Line	L700E-500	0780-1221	10-200	--	400	1/2" NPT F	1/2" NPT F	350	30
L700 High Flow Line	L700E-750	0780-1222	10-200	--	400	3/4" NPT F	3/4" NPT F	350	30
DL700 Dome Load	DL700	0780-1188	5-125	--	--	1/2" NPT F	1/2" NPT F	500	31

REGULATORS



## REGULATOR SELECTION GUIDE - BY GAS SERVICE

### INERT GAS - NITROGEN, ARGON, HELIUM

Description	Model	Part Number	Delivery Range (psig)	Gauge Range Inlet	Gauge Range Outlet	CGA Inlet Connection	Outlet Connection	Max Inlet Pressure (psig)	Page Number
ESS7 High Capacity Single Stage	ESS7-125-580	0781-5182	5-125	4000	200	580	7/8" - 14 M RH	3000	20
ESS7 High Capacity Single Stage	ESS7-200-580	0781-5185	10-200	4000	400	580	7/8" - 14 M RH	3000	20
ESS4 High Capacity Single Stage	ESS4-125-580	0781-5143	5-125	4000	200	580	5/8" - 18 F RH	3000	21
ESS4 High Capacity Single Stage	ESS4-200-580	0781-5144	10-200	4000	400	580	5/8" - 18 F RH	3000	21
ESS3 Medium Capacity Single Stage	ESS3-40-580	0781-5122	2-40	4000	60	580	5/8" - 18 F RH	3000	21
ESS3 Medium Capacity Single Stage	ESS3-125-580	0781-5116	5-125	4000	200	580	5/8" - 18 F RH	3000	21
SR 450 Heavy Duty Single Stage	SR450D-580	0781-0528	5-125	4000	200	580	5/8" - 18 F RH	3000	22
SR 450 Heavy Duty Single Stage	SR450E-580	0781-0543	10-200	4000	400	580	5/8" - 18 F RH	3000	22
VTS Extra Heavy Duty Two Stage	VTS700D-580	0780-0928	5-125	4000	200	580	7/8" - 14 M RH	3000	24
VTS Extra Heavy Duty Two Stage	VTS700E-580	0780-0943	10-200	4000	400	580	7/8" - 14 M RH	3000	24
ETS4 High Capacity Two Stage	ETS4-40-580	0781-5221	2-40	4000	60	580	5/8" - 18 F RH	3000	29
ETS4 High Capacity Two Stage	ETS4-125-580	0781-5222	5-125	4000	200	580	5/8" - 18 F RH	3000	29
ETS4 High Capacity Two Stage	ETS4-200-580	0781-5223	10-200	4000	400	580	5/8" - 18 F RH	3000	29
VTS 250 Medium Duty Two Stage	VTS250A-580	0781-3507	2-15	4000	30	580	5/8" - 18 F RH	3000	25
VTS 250 Medium Duty Two Stage	VTS250B-580	0781-3508	2-40	4000	60	580	5/8" - 18 F RH	3000	25
VTS 250 Medium Duty Two Stage	VTS250C-580	0781-3509	4-80	4000	100	580	5/8" - 18 F RH	3000	25
VTS 250 Medium Duty Two Stage	VTS250D-580	0781-3513	5-125	4000	200	580	5/8" - 18 F RH	3000	25
SR 4 High Pressure	SR4F-580	0781-1408	50-750	4000	1000	580	1/4" Swagelok®	3000	26
SR 4 High Pressure	SR4F-680	0781-1410	50-750	6000	1000	680	1/4" Swagelok	5500	26
SR 4 High Pressure	SR4G-580	0781-1428	100-1500	4000	2000	580	1/4" Swagelok	3000	26
SR 4 High Pressure	SR4G-680	0781-1430	100-1500	6000	2000	680	1/4" Swagelok	5500	26
SR 4 High Pressure	SR4J-580	0781-1448	200-3000	4000	4000	580	1/4" Swagelok	3000	26
SR 4 High Pressure	SR4J-680	0781-1450	200-3000	6000	4000	680	1/4" Swagelok	5500	26
SR 4 High Pressure	SR4J-677	0781-1453	200-3000	7500	4000	677	1/4" Swagelok	7500	26
SR 4 High Pressure	SR4K-680	0781-1470	300-4500	6000	6000	680	1/4" Swagelok	5500	26
SR 4 High Pressure	SR4K-677	0781-1473	300-4500	7500	6000	677	1/4" Swagelok	7500	26
SR 600 High Pressure	SR600-350-580	0781-1601	5-350	6000	600	580	1/4" Swagelok	5500	27
SR 600 High Pressure	SR600-350-680	0781-1604	5-350	6000	600	680	1/4" Swagelok	5500	27
SR 600 High Pressure	SR600-550-580	0781-1611	5-550	6000	1000	580	1/4" Swagelok	3000	27
ELC4 High Capacity Liquid Cylinder	ELC4-125-580R	0781-5200	5-125	-	200	580	CGA 032 5/8" - 18 UNF	3000	28
ELC4 High Capacity Liquid Cylinder	ELC4-325-580R	0781-5202	5-325	-	400	580	CGA 032 5/8" - 18 UNF	3000	28
EST4 High Capacity Station	EST4-125-034	0781-5189	5-125	-	200	034	CGA 032 5/8" - 18 UNF	200	29
EST4 High Capacity Station	EST4-125-034R	0781-5207	5-125	-	200	034	CGA 032 5/8" - 18 UNF	200	29
L700 High Flow Line	L700C-500	0780-1229	4-80	-	100	1/2" NPT F	1/2" NPT F	350	30
L700 High Flow Line	L700C-750	0780-1220	4-80	-	100	3/4" NPT F	3/4" NPT F	350	30
L700 High Flow Line	L700D-500	0780-1207	5-125	-	200	1/2" NPT F	1/2" NPT F	350	30
L700 High Flow Line	L700D-500PMT	0780-1236	5-125	-	200	1/2" NPT F	1/2" NPT F	350	30
L700 High Flow Line	L700D-750	0780-1209	-	-	200	3/4" NPT F	3/4" NPT F	350	30
L700 High Flow Line	L700E-500	0780-1221	10-200	-	400	1/2" NPT F	1/2" NPT F	350	30
L700 High Flow Line	L700E-750	0780-1222	10-200	-	400	3/4" NPT F	3/4" NPT F	350	30
DL700 Dome Load	DL700	0780-1188	5-125	-	-	1/2" NPT F	1/2" NPT F	500	31
BSL Bulk System Line	BSL700	0780-1200	10-200	-	-	1/2" NPT F	1/2" NPT F	350	31

REGULATORS

# REGULATOR SELECTION GUIDE - BY GAS SERVICE

## INERT GAS - NITROGEN, ARGON, HELIUM (CONTINUED)

Description	Model	Part Number	Delivery Range (psig)	Gauge Range Inlet	Gauge Range Outlet	CGA Inlet Connection	Outlet Connection	Max Inlet Pressure (psig)	Page Number
ESS3-FG Flow Gauge	ESS3-FG-580	0781-5120	0-40 psig	4000	50 CFH	580	CGA 032 5/8" - 18 UNF	3000	32
SLR 100 Surge Limiting Regulator	SLR100	0781-1197		--	--	030		200	34
FM150 Flow Meter Heavy Duty	FM150	1000-0268	10-60 Air* 10-30 Nit*	--	--	1/4" NPT M	5/8"-18 RH F	25	35
FM135 Flow Meter Heavy Duty	FM135	1000-0255	4-18 Argon* 10-50 Helium*	--	--	9/16"-18 RH F	5/8"-18 RH F	25	35
FM145 Flow Meter Heavy Duty	FM145	1000-0256	4-18 Argon* 10-50 Helium*	--	--	5/8" RH M	5/8"-18 RH F	25	35
FM155 Flow Meter Heavy Duty	FM155	1000-0257	4-18 Argon* 10-50 Helium*	--	--	5/8" NPT M	5/8"-18 RH F	25	35
FM137 Flow Meter Heavy Duty	FM137	1000-0261	15-65 Argon* 40-200 Helium*	--	--	9/16"-18 RH F	5/8"-18 RH F	25	35
FM147 Flow Meter Heavy Duty	FM147	1000-0262	15-70 Argon* 40-200 Helium*	--	--	5/8"-18 RH M	5/8"-18 RH F	25	35
FM157 Flow Meter Heavy Duty	FM157	1000-0263	15-65 Argon* 40-200 Helium*	--	--	1/4" NPT M	5/8"-18 RH F	25	35
FM370 Flow Meter Heavy Duty	FM370	1000-0258	5-50 Argon* 20-150 Helium*	--	--	9/16"-18 RH F	5/8"-18 RH F	25	35
FM371 Flow Meter Heavy Duty	FM371	1000-0259	5-50 Argon* 20-150 Helium*	--	--	5/8"-18 RH M	5/8"-18 RH F	25	35
FM372 Flow Meter Heavy Duty	FM372	1000-0182	5-50 Argon* 20-150 Helium*	--	--	1/4" NPT M	5/8"-18 RH F	25	37
HRF 2425 Medium Duty Flow Meter Regulator	HRF2425	0781-2731	10-50 Argon* 20-150 Helium*	--	--	580	5/8"-18 RH F	3000	36
HRF2480 Medium Duty Flow Meter Regulator	HRF2480	0781-2728	7.5-37.5 Argon*	--	--	580	5/8"-18 RH F	3000	36
DFM 150 Medium Duty Flow Meter Regulator	DFM150-580	0781-1153	5-50 Argon* 20-150 Helium*	--	--	580	5/8"-18 RH F	3000	36
HSR Medium Duty Flow Meter Regulator Single Stage	HSR2530	0781-3819	10-60 Nitrogen*	--	--	580	5/8"-18 RH F	3000	37
HSR Medium Duty Flow Meter Regulator Single Stage	HSR2535	0781-3867	4-18 Argon* 10-50 Helium*	--	--	580	5/8"-18 RH F	3000	37
HVTS Medium Duty Flow Meter Regulator Two Stage	HVTS2535	0781-3775	4-18 Argon* 10-50 Helium*	--	--	580	5/8"-18 RH F	3000	37
HSR Medium Duty Flow Meter Regulator Single Stage	HSR2537	0781-3871	15-65 Argon* 40-200 Helium*	--	--	580	5/8"-18 RH F	3000	37
HVTS Medium Duty Flow Meter Regulator Two Stage	HVTS2537	0781-3772	15-65 Argon* 40-200 Helium*	--	--	580	5/8"-18 RH F	3000	37
HSR Medium Duty Flow Meter Regulator Single Stage	HSR2570	0781-3873	5-50*	--	--	580	5/8"-18 RH F	3000	37
HSR Medium Duty Flow Meter Regulator Single Stage	HSR2570	0781-3869	4-40*	--	--	580	5/8"-18 RH F	3000	37
HVTS Medium Duty Flow Meter Regulator Two Stage	HVTS2570	0781-3774	20-150*	--	--	580	5/8"-18 RH F	3000	37

\*Delivery range measured in CFH

REGULATORS

## REGULATOR SELECTION GUIDE - BY GAS SERVICE

### BRITISH OXYGEN

Description	Model	Part Number	Delivery Range (psig)	Gauge Range Inlet	Gauge Range Outlet	CGA Inlet Connection	Outlet Connection	Max Inlet Pressure (psig)	Page Number
ESS7 High Capacity Single Stage	ESS7-200-992	0781-5220	10-200	4000	400	992	7/8" - 14 M RH	3000	20
ESS4 High Capacity Single Stage	ESS4-200-992	0781-5155	10-200	4000	400	992	9/16" - 18 M RH	3000	21
ESS4 High Capacity Single Stage	ESS4-125-992	0781-5128	5-125	4000	200	992	9/16" - 18 M RH	3000	21
ETS4 High Capacity Two Stage	ETS4-125-992	0785-2120	5-125	4000	200	992	9/16" - 18 M RH	3000	25
ETS4 High Capacity Two Stage	ETS4-200-992	0785-2121	10-200	4000	400	992	9/16" - 18 M RH	3000	25
DL700 Dome Load	DL700	0780-1188	5-125	-	-	1/2" NPT F	1/2" NPT F	500	31

### METHANE/HYDROGEN

Description	Model	Part Number	Delivery Range (psig)	Gauge Range Inlet	Gauge Range Outlet	CGA Inlet Connection	Outlet Connection	Max Inlet Pressure (psig)	Page Number
ESS7 High Capacity Single Stage	ESS7-200-350	0781-5186	10-200	4000	400	350	7/8" - 14 M RH	3000	20
ESS4 High Capacity Single Stage	ESS4-125-350	0781-5137	5-125	4000	200	350	9/16" - 18 M LH	3000	21
ESS4 High Capacity Single Stage	ESS4-200-350	0781-5138	10-200	4000	400	350	9/16" - 18 M LH	3000	21
ESS3 Medium Capacity Single Stage	ESS3-40-350	0781-5110	2-40	4000	60	350	9/16" - 18 M LH	3000	21
ESS3 Medium Capacity Single Stage	ESS3-125-350	0781-5111	5-125	4000	200	350	9/16" - 18 M LH	3000	21
ETS4 High Capacity Two Stage	ETS4-40-350	0781-5225	2-40	4000	60	350	9/16" - 18 M LH	3000	25
VTS 250 Medium Duty Two Stage	VTS252A-350	0781-3558	2-15	4000	30	350	9/16" - 18 M LH	3000	25
VTS 250 Medium Duty Two Stage	VTS252B-350	0781-3559	2-40	4000	60	350	9/16" - 18 M LH	3000	25
VTS 250 Medium Duty Two Stage	VTS252C-350	0781-3563	4-80	4000	100	350	9/16" - 18 M LH	3000	25
VTS 250 Medium Duty Two Stage	VTS252D-350	0781-3564	5-125	4000	200	350	9/16" - 18 M LH	3000	25
SR 4 High Pressure Manifold	SR4F-350	0781-1404	50-750	4000	1000	350	1/4" Swagelok®	3000	26
SR 4 High Pressure Manifold	SR4G-350	0781-1424	100-1500	4000	2000	350	1/4" Swagelok	3000	26
SR 4 High Pressure Manifold	SR4J-350	0781-1444	200-3000	4000	4000	350	1/4" Swagelok	3000	26
ESL4 High Capacity Line	ESL4-80-250F	0781-5210	4-80	-	100	1/4" NPT F	1/4" NPT F	3000	29
ESL4 High Capacity Line	ESL4-125-250F	0781-5211	5-125	-	200	1/4" NPT F	1/4" NPT F	3000	29
EST4 High Capacity Station	EST4-80-025	0781-5195	4-80	-	100	025	9/16" - 18 M LH	200	29
EST4 High Capacity Station	EST4-80-025R	0781-5212	4-80	-	100	025	9/16" - 18 M LH	200	29
EST4 High Capacity Station	EST4-125-025	0781-5196	5-125	-	200	025	9/16" - 18 M LH	200	29
EST4 High Capacity Station	EST4-125-025R	0781-5213	5-125	-	200	025	9/16" - 18 M LH	200	29
L700 High Flow Line	L711D-500	0780-1199	5-125	-	200	1/2" NPT F	1/2" NPT F	350	30
HSR Medium Duty Flow Meter Regulator Single Stage	HSR2533	0781-3825	5-40*	-	-	350	9/16" - 18 M LH	3000	37

### NITROUS OXIDE

Description	Model	Part Number	Delivery Range (psig)	Gauge Range Inlet	Gauge Range Outlet	CGA Inlet Connection	Outlet Connection	Max Inlet Pressure (psig)	Page Number
ESL4 High Capacity Line	ESL4-125-250	0781-5190	5-125	-	200	1/4" NPT F	1/4" NPT F	3000	29
DL700 Dome Load	DL700	0780-1188	5-125	-	-	1/2" NPT F	1/2" NPT F	500	30

# REGULATOR SELECTION GUIDE - BY GAS SERVICE

## CARBON DIOXIDE

Description	Model	Part Number	Delivery Range (psig)	Gauge Range Inlet	Gauge Range Outlet	CGA Inlet Connection	Outlet Connection	Max Inlet Pressure (psig)	Page Number
ESS4 High Capacity Single Stage	ESS4-200-320	0781-5147	10-200	4000	400	320	CGA 032 5/8" – 18 UNF	3000	21
ESS3 Medium Capacity Single Stage	ESS3-125-320	0781-5121	5-125	4000	200	320	CGA 032 5/8" – 18 UNF	3000	21
ETS4 High Capacity Two Stage	ETS4-125-320	0781-5228	5-125	4000	200	320	CGA 032 5/8" – 18 UNF	3000	25
VTS 250 Medium Duty Two Stage	VTS253A-320	0781-3569	2-15	4000	30	320	CGA 032 5/8" – 18 UNF	3000	25
VTS 250 Medium Duty Two Stage	VTS253B-320	0781-3573	2-40	4000	60	320	CGA 032 5/8" – 18 UNF	3000	25
VTS 250 Medium Duty Two Stage	VTS253C-320	0781-3574	4-80	4000	100	320	CGA 032 5/8" – 18 UNF	3000	25
VTS 250 Medium Duty Two Stage	VTS253D-320	0781-3575	5-125	4000	200	320	CGA 032 5/8" – 18 UNF	3000	25
SR 4 High Pressure Manifold	SR4F-320	0781-1401	50-750	4000	1000	320	CGA 032 5/8" – 18 UNF	3000	26
ELC4 High Capacity Liquid Cylinder	ELC4-125-320R	0781-5201	5-125	–	200	320	CGA 032 5/8" – 18 UNF	3000	28
ESL4 High Capacity Line	ESL4-125-250	0781-5190	5-125	–	200	1/4" NPT F	1/4" NPT F	3000	29
DL700 Dome Load	DL700	0780-1188	5-125	–	–	1/2" NPT F	1/2" NPT F	500	30
ESS3-FG Flow Gauge	ESS3-FG-320	0781-5119	0-40*	4000	50 CFH	320	CGA 032 5/8" – 18 UNF	3000	32
SR310 Regulator Adjustable Pressure	SR310	0781-0355	10-150*	1500	200	320	CGA 032 5/8" – 18 UNF	1500	33
SR311 Flow Meter	SR311	0781-0353	25-100*	1500	–	320	CGA 032 5/8" – 18 UNF	1500	33
SR312 Flow Gauge	SR312	0781-0354	0-100*	–	–	320	CGA 032 5/8" – 18 UNF	1500	33
FM200 Heavy Duty Flow Meter	FM200	1000-0264	30-100*	–	–	1/4" NPT M	5/8"-18RH M	30	35
FM370 Flow Meter Heavy Duty	FM370	1000-0258	5-40*	–	–	9/16"-18 RH F	5/8"-18 RH F	25	35
FM371 Flow Meter Heavy Duty	FM371	1000-0259	5-40*	–	–	5/8"-18 RH M	5/8"-18 RH F	25	35
FM372 Flow Meter Heavy Duty	FM372	1000-0182	5-40*	–	–	1/4" NPT M	5/8"-18 RH F	25	35
HRF2480 Medium Duty Flow Meter Regulator	HRF2480	0781-2727	10-38*	–	–	320	5/8"-18 RH F	3000	36
HRF2480 Medium Duty Flow Meter Regulator	HRF2480	0781-2728	7.5-37.5*	–	–	320	5/8"-18 RH F	3000	36
DMF150 Medium Duty Flow Meter Regulator	DFM150S	0781-1206	5-40*	–	–	1/4" NPT M	5/8"-18 RH F	3000	36
HSR Medium Duty Flow Meter Regulator	HSR2530	0781-3819	10-60*	–	–	580	5/8"-18 RH F	3000	37

\*Delivery Range measured in CFH

## L.P. GAS

Description	Model	Part Number	Delivery Range (psig)	Gauge Range Inlet	Gauge Range Outlet	CGA Inlet Connection	Outlet Connection	Max Inlet Pressure (psig)	Page Number
ESS7 High Capacity Single Stage	ESS7-125-510LP	0781-5188	5-125	400	200	510	7/8" – 14 M LH	350	20
ESS4 High Capacity Single Stage	ESS4-40-510LP	0781-5135	2-40	400	60	510	9/16" – 18 M LH	350	21
ESS4 High Capacity Single Stage	ESS4-125-510LP	0781-5136	5-125	400	200	510	9/16" – 18 M LH	350	21
ESS3 Medium Capacity Single Stage	ESS3-40-510LP	0781-5108	2-40	400	60	510	9/16" – 18 M LH	350	21
ESS3 Medium Capacity Single Stage	E SS3-125-510LP	0781-5109	5-125	400	200	510	9/16" – 18 M LH	350	21
SR450 Heavy Duty Single Stage	SR461B-510	0781-0589	2-40	400	60	510	9/16" – 18 M LH	350	22
SR450 Heavy Duty Single Stage	SR461D-510	0781-0595	5-125	400	200	510	9/16" – 18 M LH	350	22
SR 250 Medium Duty Single Stage	SR261B-510	0781-0095	2-40	400	60	510	9/16" – 18 M LH	350	23
SR 250 Medium Duty Single Stage	SR261C-510	0781-0098	4-80	400	100	510	9/16" – 18 M LH	350	23
VTS 250 Medium Duty Two Stage	VTS261B-510	0781-3594	2-40	400	60	510	9/16" – 18 M LH	350	25
VTS 250 Medium Duty Two Stage	VTS250BL-555	0781-3525	2-40	400	60	510	9/16" – 18 M LH	350	25
ESL4 High Capacity Line	ESL4-80-250F	0781-5210	4-80	–	100	1/4" NPT F	1/4" NPT F	3000	29
ESL4 High Capacity Line	ESL4-125-250F	0781-5211	5-125	–	200	1/4" NPT F	1/4" NPT F	3000	29
EST4 High Capacity Station	EST4-80-025	0781-5195	4-80	–	100	025	9/16" – 18 M LH	200	29
EST4 High Capacity Station	EST4-80-025R	0781-5212	4-80	–	100	025	9/16" – 18 M LH	200	29
EST4 High Capacity Station	EST4-125-025	0781-5196	5-125	–	20	025	9/16" – 18 M LH	200	29
EST4 High Capacity Station	EST4-125-025R	0781-5213	5-125	–	200	025	9/16" – 18 M LH	200	29
L700 High Flow Line	L711D-500	0780-1199	5-125	–	200	1/2" NPT F	1/2" NPT F	350	30

## SINGLE STAGE REGULATORS

Recommended for applications where slight delivery pressure increases (due to decreasing cylinder pressures) would not affect the performance characteristics of the work or test results.

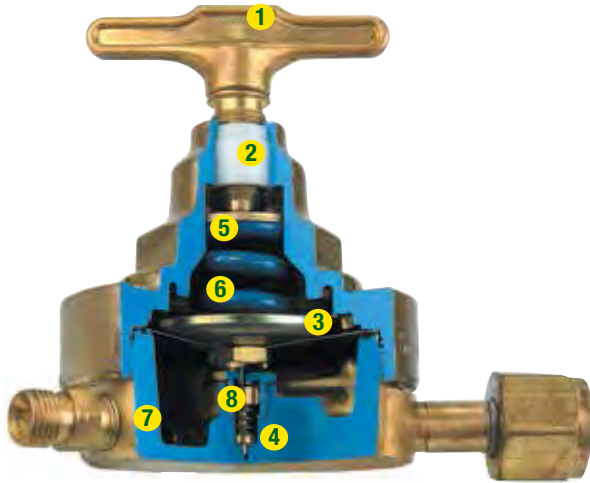

Typical Single Stage Design SR 450 Series Shown  
2.5" (63.5 mm) Brass Gauges External Relief Valve System

- 1 Brass Adjusting Screw with forged T-handle (SR 450 only)
- 2 Delrin Insert Bushing for durability, easier adjusting
- 3 Stainless Steel Diaphragm gives accurate long lasting service
- 4 Stem-Type Seat Mechanism inlet pressure aids in sealing
- 5 Stainless Ball in Key for easy adjustment
- 6 Adjusting Spring pretested for quality assurance
- 7 Die-Forged Brass Body for extra strength
- 8 Precision Machined Nozzle for optimum flow control

### Additional Features

- External self reseating relief valve. Not designed to protect downstream equipment (no relief valve is needed on low pressure fuel gas models)
- Sintered inlet filter, electroless nickel plated bronze
- Regulators will deliver at least the stated upper range and in some cases may exceed the stated upper range

## EDGE™ SERIES

### INNOVATIVE EDGE™ SERIES REGULATORS OFFER SAFETY AND ADVANCED DESIGN

Victor® has been the leader in gas equipment for one hundred years, and its tradition of unparalleled safety remains a cornerstone of the brand today. With the Victor Professional EDGE Series Regulators, Victor continues to offer the safest, most reliable and highest quality gas control technology, giving you more value for your purchase. In addition, standardized designs and components throughout the EDGE family greatly simplify regulator service and repair.

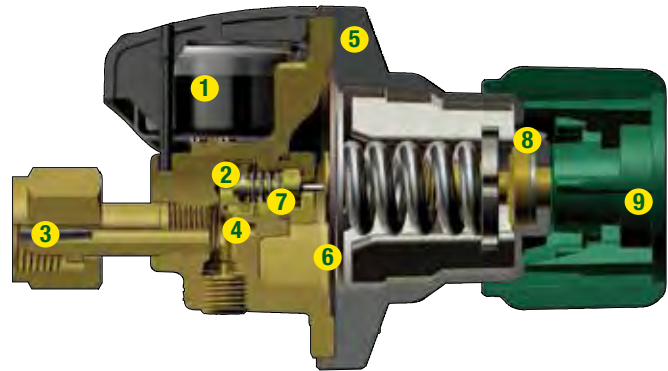

- 1 Gauges are recessed into the body for the highest level of safety and protection possible
- 2 More efficient internal flow paths translate to improved flow consistency from full to empty cylinder
- 3 Same sintered inlet filter used in all Victor industrial regulators
- 4 Innovative design elements enable the regulator to meet or exceed oxygen-related safety standards CGA E-4, UL 252, and the stringent ASTM G-175 Promoted Ignition Test
- 5 Housing cap is made from high strength zinc-aluminum alloy that has nearly twice the yield strength of forged brass
- 6 Time-tested fabric reinforced neoprene diaphragm provides superior sensitivity and control
- 7 Seat assembly and friction damper are the same tried and true components used for decades in SR 350 and SR 450
- 8 Internals remain protected from weather elements through an internal vent system protected under the knob, which is channeled to promote water run-off
- 9 SLAM™ Knob designed with multi-stage crumple zones which absorb impact energy in the event the cylinder falls over. Helps protect pressure integrity of both regulator and cylinder valve.

### Additional Features

- Forged brass body
- External self reseating relief valve. Not designed to protect downstream equipment (no relief valve is needed on low pressure fuel gas models).



## ESS7

### HIGH FLOW

#### DESIGN/CONSTRUCTION

- 2.5" (63.5 mm) gauges – brass
- 2.7" (68.6 mm) diaphragm – fabric reinforced neoprene

#### DIMENSIONS

6.8"W x 6.9"H x 5.4"D  
(172.7 mm x 175.3 mm x 137.1 mm)

#### WEIGHT

4.9 lb (2.22 kg)



### ESS7 FLOW DATA - EDGE Series High-Flow

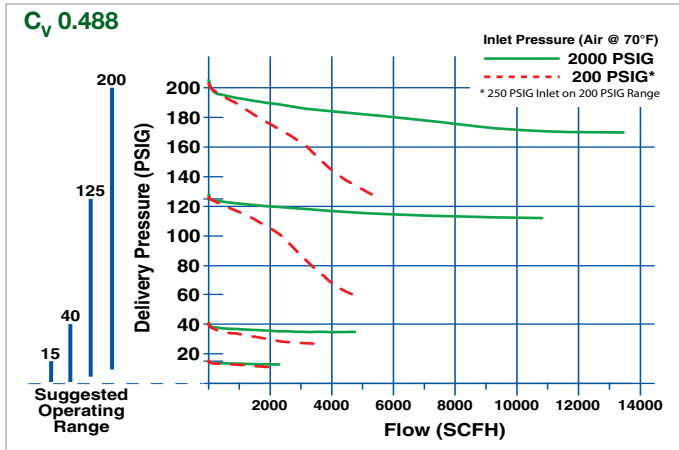

Gas Service	Part No.	Model No.	Delivery Range (psig)
Air, Oxygen, Inert Gas	0781-5184	ESS7-200-346	10-200
	0781-5181	ESS7-125-540	5-125
	0781-5183	ESS7-200-540	10-200
	0781-5220	ESS7-200-992	10-200
	0781-5182	ESS7-125-580	5-125
0781-5185	ESS7-200-580	10-200	
Methane/Hydrogen	0781-5186	ESS7-200-350	10-200
Acetylene	0781-5187	ESS7-15-510	2-15
L.P. Gas	0781-5188	ESS7-125-510LP	5-125

Outlet Connection 7/8"-14(M)  
Like other regulators



### EDGE ADJUSTING LOCK

Ideal for setting pressures and avoiding tampering by others. Comes with three color decals - red, green, black.



Part No: 0750-0221

## SR 450

### HEAVY DUTY

#### DESIGN/CONSTRUCTION

- 2.5" (63.5 mm) gauges – brass
- 3.25" (82.6 mm) diaphragm – stainless steel

#### DIMENSIONS

7.25 W x 7" H x 5.13" D  
(184.2 mm x 177.8 mm x 130.3 mm)

#### WEIGHT

5 lb 2 oz (2.32 kg)

The shape of the SR450 Series regulator is a registered trademark of Victor.



#### PERFORMANCE

Maximum inlet – 3000 psig

### FLOW (SCFH)

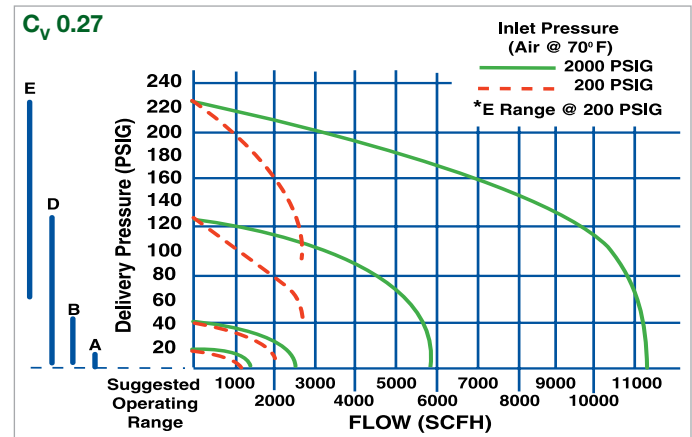

Gas Service	Part No.	Model No.	Delivery Range (psig)
Air, Oxygen, Inert Gas	0781-0532	SR 450D-346	5-125
	0781-0527	SR 450D-540	5-125
	0781-0528	SR 450D-580*	5-125
	0781-0543	SR 450E-580*	10-200
Acetylene	0781-0583	SR 460A-300	2-15
	0781-0584	SR 460A-510	2-15
L.P. Gas	0781-0589	SR 461B-510	2-40
	0781-0595	SR 461D-510	5-125

Outlet Connections: Cylinder Type – 9/16"-18 (M), \*9/16"-18 (F) RH

## ESS4

### HIGH CAPACITY

#### DESIGN/CONSTRUCTION

- High impact ABS gauge guard
- 1.5" (40 mm) gauges – steel
- 2.7" (68.6 mm) diaphragm – fabric reinforced neoprene

#### DIMENSIONS

6.8" W x 4.4" H x 3.9" D  
(172.7 mm x 111.8 mm x 99.1 mm)

#### WEIGHT

4.0 lb (1.81kg)



## ESS3

### MEDIUM CAPACITY

#### DESIGN/CONSTRUCTION

- High impact ABS gauge guard
- 1.5" (40 mm) gauges – steel
- 2" (50.8 mm) diaphragm – fabric reinforced neoprene.

#### DIMENSIONS

6.6"W x 4.4"H x 3.6"D  
(167.6 mm x 111.8 mm x 91.4 mm)

#### WEIGHT

3.5 lb (1.59 kg)



### ESS4 FLOW DATA

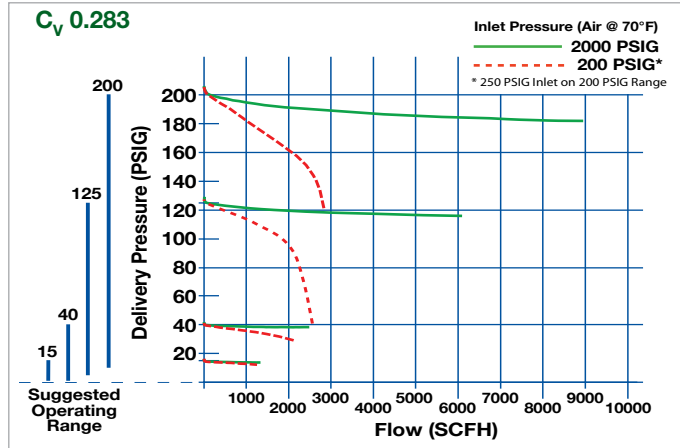

### ESS3 FLOW DATA

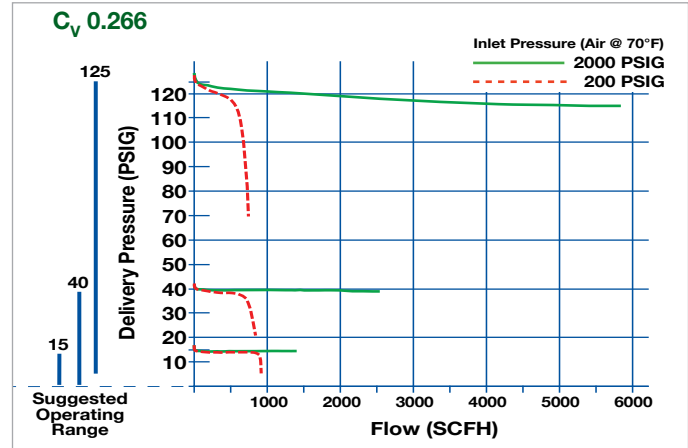

Gas Service	Part No.	Model No.	Delivery Range (psig)
Air, Oxygen, Inert Gas	0781-5142	ESS4-125-346	5-125
	0781-5145	ESS4-200-346	10-200
	0781-5154	ESS4-40-540	2-40
	0781-5127	ESS4-125-540	5-125
	0781-5161	ESS4-125-540L	5-125
	0781-5131	ESS4-200-540	10-200
	0781-5143	ESS4-125-580	5-125
	0781-5144	ESS4-200-580	10-200
	0781-5152	ESS4-200-580L	10-200
	0781-5146	ESS4-125-590	5-125
British Oxygen	0781-5128	ESS4-125-992	5-125
	0781-5155	ESS4-200-992	10-200
Methane/Hydrogen	0781-5137	ESS4-125-350	5-125
	0781-5138	ESS4-200-350	10-200
Carbon Dioxide	0781-5147	ESS4-200-320	10-200
	0781-5133	ESS4-15-300	2-15
Acetylene	0781-5160	ESS4-15-300L	2-15
	0781-5140	ESS4-15-410	2-15
	0781-5132	ESS4-15-510	2-15
	0781-5134	ESS4-15-993	2-15
Acetylene (longer swivel)	0781-5159	ESS4-15-510L	2-15
L.P. Gas	0781-5135	ESS4-40-510LP	2-40
	0781-5136	ESS4-125-510LP	5-125

Gas Service	Part No.	Model No.	Delivery Range (psig)
Air, Oxygen, Inert Gas	0781-5115	ESS3-125-346	5-125
	0781-5100	ESS3-125-540	5-125
	0781-5122	ESS3-40-580	2-40
	0781-5116	ESS3-125-580	5-125
Acetylene	0781-5106	ESS3-15-300	2-15
	0781-5105	ESS3-15-510	2-15
L.P. Gas	0781-5108	ESS3-40-510LP	2-40
	0781-5109	ESS3-125-510LP	5-125
Methane Hydrogen	0781-5110	ESS3-40-350	2-40
	0781-5111	ESS3-125-350	5-125
Carbon Dioxide	0781-5121	ESS3-125-320	5-125



SINGLE IMPACT POINT

#### 3-Stage Crumple Zone

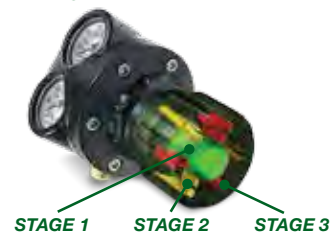

SHOCK ABSORBING KNOB

## SR 350

HEAVY/MEDIUM DUTY

### DESIGN/CONSTRUCTION

- 2.5" (63.5 mm) gauges – brass
- 2.75" (69.9 mm diaphragm – fabric reinforced neoprene

### DIMENSIONS

7.5" W x 6.5" H x 4.5" D  
(190.5 mm x 165.1 mm x 114.3 mm)

### WEIGHT

3 lb 8 oz (1.59 kg)

### PERFORMANCE

Maximum inlet – 3000 psig



### ESS7 FLOW DATA - (Flowing Air at STD. Conditions)

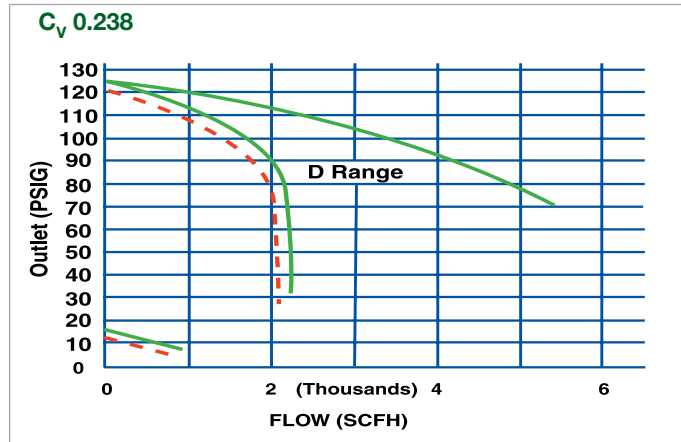

Gas Service	Part No.	Model No.	Delivery Range (psig)
Oxygen	0781-2341	SR 350D-540	5-125
Acetylene	0781-2400	SR 360A-300**	2-15
	0781-2401	SR 360A-510	2-15

Outlet Connections: Cylinder Type – 9/16"-18 (M), \*\*9/16"-18 (M) LH



## G350

HEAVY DUTY

### DESIGN/CONSTRUCTION

- Larger regulator body for heavy duty applications
- Color coded knobs
- Forged brass body & Zinc Aluminum housing cap
- 2" (50.8 mm) gauges
- 9/16"-18 outlet connection
- Internal relief

### WEIGHT

3.55 lb (1.61kg)



### G350 FLOW DATA

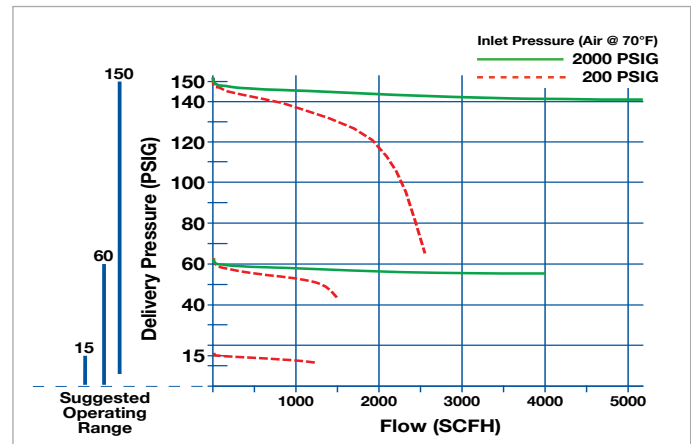

Gas Service	Part No.	Model No.	Delivery Range (psig)
Oxygen	0781-9415	G350-150-540	150
Acetylene	0781-9421	G350-15-300	15
Inert	0781-9416	G350-150-580	150
	0781-9420	G350-15-510	15
LP	0781-9422	G350-60-510LP	60

Watch the Victor EDGE™ Regulator  
SLAM Safety Video

[www.youtube.com/watch?v=35ejr42XFnM](http://www.youtube.com/watch?v=35ejr42XFnM)

## G250

MEDIUM DUTY

### DESIGN/CONSTRUCTION

- Compact size for light to medium duty applications
- Acetylene, Oxygen and LP gas models
- Color coded knobs
- Single stage
- Forged brass body & Zinc Aluminum housing cap
- 2" (50.8 mm) gauges
- Delivery ranges vary based on model (see ordering information)
- 9/16"-18 outlet connection
- Internal relief



### WEIGHT

3 lb (1.36 kg)

### G250 FLOW DATA

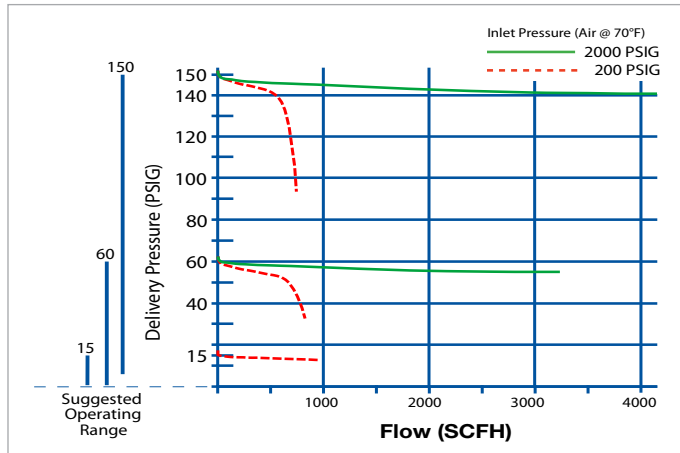

Gas Service	Part No.	Model No.	Delivery Range (psig)
Oxygen	0781-9400	G250-150-540	150
Acetylene	0781-9405	G250-15-510	15
	0781-9406	G250-15-300	15
LP	0781-9410	G250-60-510LP	60

## SR 250

MEDIUM DUTY

### DESIGN/CONSTRUCTION

- 2" (50.8 mm) gauges – brass
- 1.75" (44.5 mm) diaphragm – fabric reinforced neoprene

### DIMENSIONS

6.38" W x 5.13" H x 4.25" D  
(162.0 mm x 130.3 mm x 108.0 mm)

### WEIGHT

2 lb 15 oz (1.33 kg)

### PERFORMANCE

Maximum inlet – 3000 psig



### SR250 FLOW DATA

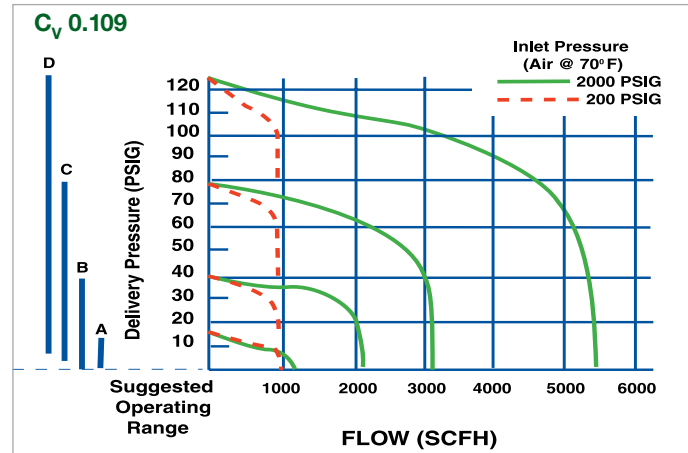

Gas Service	Part No.	Model No.	Delivery Range (psig)
Oxygen	0781-0027	SR 250C-540	4-80
	0781-0043	SR 250D-540	5-125
	0781-0085	SR 260A-300	2-15
Acetylene	0781-0087	SR 260A-510	2-15
	0387-0115	SR 260A-510 CS	2-15
L.P. Gas	0781-0095	SR 261B-510	2-40
	0781-0098	SR 261C-510	4-80

CS = Clamshell Packaging  
Outlet Connections: Cylinder Type – 9/16"-18 (M)

## GAUGE GUARDS

Gas Service	Part No.	Model No.
Oxygen	1429-0056	SR 450/VTS 450
	1429-0066	SR 350
	1429-0068	SR 250/VTS 250
Acetylene	1429-0057	SR 450/VTS 450
	1429-0067	SR 350
	1429-0069	SR 250/VTS 250



- Protects your gauges
- Color-coded for easy identification

## SR 5/SR 6

### LIGHT DUTY

#### DESIGN/CONSTRUCTION

- Light weight, compact
- Machined brass body & housing cap
- 1.5" (38.1 mm) gauges - brass
- Stem type seat mechanism
- 1.25" (31.8 mm) diaphragm - fabric reinforced neoprene
- Internal self reseating diaphragm relief valve (no relief valve is needed on SR 6 Series regulators).
- Sintered inlet filter - bronze

#### DIMENSIONS

4.75" W x 4.25" H x 3.25" D  
(120.7 mm x 108.0 mm x 82.6 mm)

#### WEIGHT

1 lb 12 oz (0.79 kg)

#### PERFORMANCE

Maximum inlet – 3000 psig  
Delivery range (See chart)

Regulators will deliver at least the stated upper range at no flow and in some cases may exceed the stated upper range.



#### SR 5 / SR 6 FLOW DATA

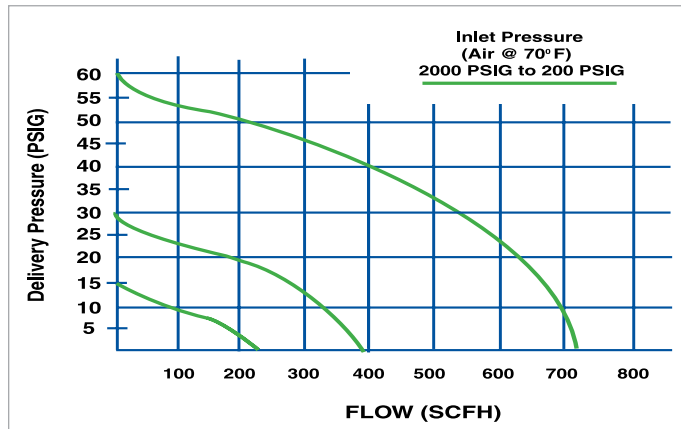

Gas Service	Part No.	Model No.	Delivery Range (psig)
Oxygen, CO <sub>2</sub> , Inert Gas	0780-2544	SR 5-40-320	2-40
	0780-2537	SR 5-40-580	2-40
	0780-2520	SR 5-60-540 CS	2-60
	0781-2545	SR 5-60-540R CS	2-60
Acetylene	0780-2521	SR 6-15-510 CS	2-15
	0780-2524	SR 6-15-200	2-15
	0781-2546	SR 6-15-200R CS	2-15
L.P. Gas	0780-2533	SR 7-40-510 CS	2-40

Outlet Connections: 9/16"-18 (M), 5/8"-18 (F)

## GF250

### MEDIUM CAPACITY

#### DESIGN/CONSTRUCTION

- Dual 2" gauges
- Zinc-Aluminum bonnet
- Single stage design
- Ergonomic adjusting knob
- For Argon or Argon/CO<sub>2</sub> mix shielding gases
- Color scale graphics with MIG and TIG ranges

#### WEIGHT

2.10 lb (1.22 kg)

#### PERFORMANCE

Maximum inlet pressure: 3000 psig  
Up to 50 CFH / for Argon and up to 38 CFH / for CO<sub>2</sub>



Part No.	Description
0781-9411	GF250-50-580
0781-9412	GF250-50-580 (with 10' hose)

Outlet Connection: 5/8"-18 RH(F)  
CS = Clamshell Package

## AF & CF 150

### LIGHT DUTY

#### DESIGN/CONSTRUCTION

- Single stage design
- Forged brass body & housing cap
- Stem type seat mechanism
- Argon, Argon/CO<sub>2</sub> mix & CO<sub>2</sub> models
- Available in CGA 320 & 580 inlet connections
- Optional MIG kit available with 10' (3.1 m) hose

#### WEIGHT

1.90 lb (0.86kg)

#### PERFORMANCE

Maximum inlet pressure: 3000 psig  
Up to 50 CFH / for Argon and up to 38 CFH / for CO<sub>2</sub>



Part No.	Model No.
0781-1103	AF 150-580 CS (With 10' (3.1m) hose)
0387-0245	AF 150-580 CS
0781-1120	CF 153-320
0781-1123	CF 153-320 CS (With 10' (3.1 m) hose)

Outlet Connection: 5/8"-18 RH(F)  
CS = Clamshell Package

## TWO STAGE REGULATORS

Recommended for applications that require a constant delivery pressure over a range of decreasing inlet pressures. This precise two stage regulator provides superior operating characteristics for applications where change in delivery pressure would affect performance characteristics of work or test results.

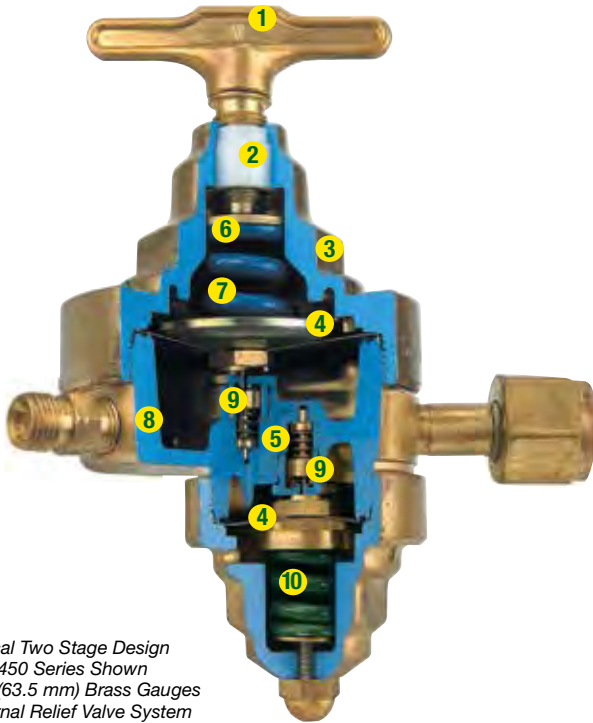

Typical Two Stage Design  
VTS 450 Series Shown  
2.5" (63.5 mm) Brass Gauges  
External Relief Valve System

- 1 Brass Adjusting Screw with forged T-handle (VTS 700 only)
- 2 Delrin Insert Bushing for durability, easier adjusting
- 3 Die-Forged Brass Spring Housing Cap provides greater strength and durability
- 4 Stainless Steel Diaphragm gives accurate long lasting service
- 5 Stem-Type Seat Mechanism inlet pressure aids in sealing
- 6 Stainless Ball in Key for easy adjustment
- 7 Adjusting Spring pretested for quality assurance
- 8 Die-Forged Brass Body for extra strength
- 9 Precision Machined Nozzle for optimum flow control
- 10 Adjusting Spring designed for precise preset

### Additional Features

- External self reseating relief valve. Not designed to protect downstream equipment (no relief valve is needed on low pressure fuel gas models) Sintered inlet filter, electroless nickel plated bronze
- Regulators will deliver at least the stated upper range and in some cases may exceed the stated upper range

## VTS 700

EXTRA HEAVY DUTY, TWO-STAGE, HIGH FLOW

### DESIGN/CONSTRUCTION

- 2.5" (63.5 mm) gauges – steel
- Diaphragms – 2" (50.8 mm) and 3.25" (82.6 mm) – stainless steel

### DIMENSIONS

6.75" W x 7.5" H x 8.63" D  
(171.5 mm x 190.5 mm x 219.1 mm)

### WEIGHT

8 lb 8 oz (3.86 kg)

### PERFORMANCE

Maximum inlet – 3000 psig



### VTS 700 FLOW DATA

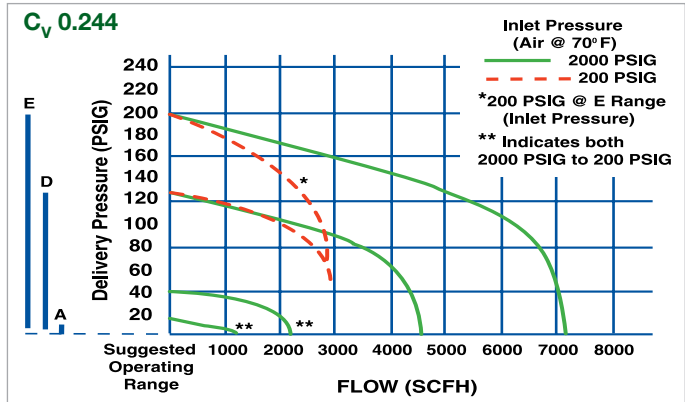

Gas Service	Part No.	Model No.	Delivery Range (psig)
Oxygen, Inert Gas	0780-0928	VTS 700D-580	5-125
	0780-0939	VTS 700E-540	10-200
	0780-0943	VTS 700E-580	10-200
Acetylene	0780-0984	VTS 710A-510	2-15

Outlet Connections: 7/8"-14(M)

## ETS4 SERIES

### HIGH CAPACITY, TWO-STAGE DESIGN

Compact two-stage performance in a single-stage footprint

#### DESIGN/CONSTRUCTION

- Forged brass body
- Zinc-aluminum housing caps
- High impact ABS gauge guard
- 1.5" UL listed/recognized Gauges – brass
- Stem type seat mechanism: urethane seat material – air, oxygen, inerts, CO<sub>2</sub>, N<sub>2</sub>O, other high pressure gases; neoprene seat material – low pressure fuel gases
- 2.7" fabric reinforced neoprene diaphragm in 2nd stage, 0.75" diameter brass piston in 1st stage
- External self reseating relief valve. Not designed to protect downstream equipment (no relief valve is needed on low pressure fuel gas models)
- Sintered inlet filter – nickel plated bronze
- SLAM™ impact absorbing safety knob
- Meets or exceeds CGA E-4, UL 252 and ASTM G-175 Promoted Ignition Test



#### DIMENSIONS

6.85" W x 4.4" H x 4.72" D (174.0 mm x 111.8 mm x 119.9 mm)

#### WEIGHT

4 lb 12 oz (2.15 kg)

#### ETS4 FLOW DATA

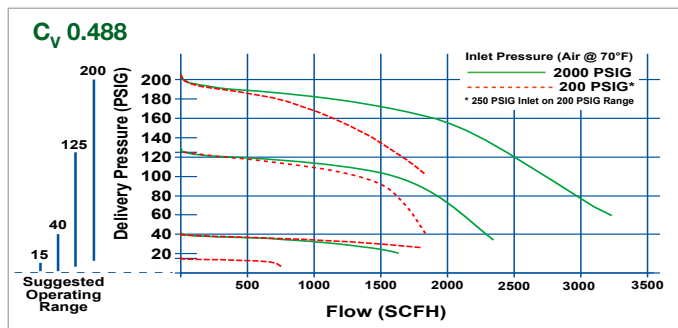

Gas Service	Part No.	Model No.	Delivery Range (psig)
Air, Oxygen, Inert Gas	0781-5231	ETS4-125-346	5-125
	0781-5232	ETS4-200-346	10-200
	0781-5217	ETS4-40-540	2-40
	0781-5218	ETS4-125-540	5-125
	0781-5219	ETS4-200-540	10-200
	0781-5221	ETS4-40-580	20-40
	0781-5222	ETS4-125-580	5-125
	0781-5223	ETS4-200-580	10-200
Industrial Air	0781-5224	ETS4-125-590	5-125
British Oxygen/ Fuel	0785-2120	ETS4-125-992	5-125
	0785-2121	ETS4-200-992	10-200
	0785-2122	ETS4-15-993	2-15
Hydrogen/Methane	0781-5225	ETS4-40-350	2-40
	0781-5226	ETS4-125-350	5-125
	0781-5227	ETS4-200-350	10-200
Carbon Dioxide	0781-5228	ETS4-125-320	5-125
Acetylene	0781-5229	ETS4-15-300	2-15
	0781-5230	ETS4-15-510	2-15

## GT350

### HEAVY DUTY, TWO-STAGE DESIGN

#### DESIGN/CONSTRUCTION

- 2" (50.8 mm) gauges – steel
- Diaphragms –  
1.33" (33.8 mm) first stage  
2.69" (68.3 mm) second stage  
fabric reinforced neoprene

#### DIMENSIONS

6.79" W x 5.31" H x 6.80" D  
(172.5 mm x 134.9 mm x 172.7 mm)

#### WEIGHT

3 lb 12 oz (1.70 kg)

#### PERFORMANCE

Maximum inlet – 3000 psig



#### GT350 TWO STAGE FLOW DATA

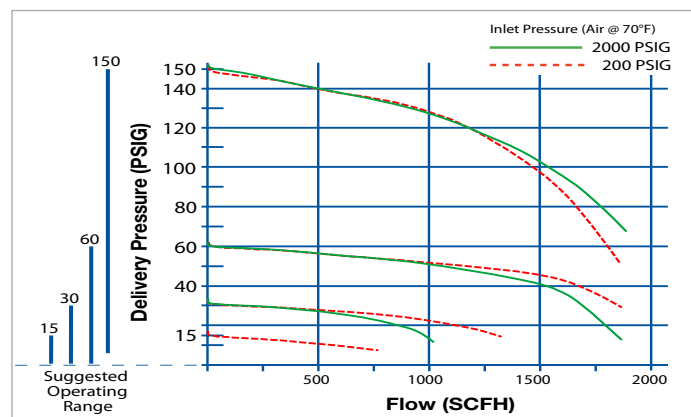

Gas Service	Part No.	Model No.	Delivery Range (psig)
Air, Oxygen, Inert Gas	0781-4255	GT350-150-346	5-150
	0781-4260	GT350-60-540	2-60
	0781-4261	GT350-150-540	5-150
	0781-4263	GT350-30-580	2-30
	0781-4264	GT350-60-580	2-60
British Oxygen/ Fuel	0781-4265	GT350-150-580	5-150
	0781-4269	GT350-150-992	5-150
	0781-4270	GT350-15-993	2-15
Hydrogen/Methane	0781-4256	GT350-60-350	2-60
	0781-4257	GT350-150-350	5-150
Carbon Dioxide	0781-4253	GT350-60-320	2-60
	0781-4254	GT350-150-320	5-150
Acetylene	0781-4252	GT350-15-300	2-15
	0781-4258	GT350-15-510	2-15
L.P. Gas	0781-4259	GT350-60-510LP	2-60

## SR 4

### HIGH PRESSURE

Heavy duty, high pressure piston regulator. Ideally suited for pressure vessel and dead-end testing. Delivery pressures up to 4500 psig on some models.

#### DESIGN/CONSTRUCTION

- Machined brass body & housing cap
- 2.5" (63.5 mm) gauges – brass
- Cartridge type seat assembly with PCTFE seat
- Piston type actuation – brass
- Delrin cap bushing for smooth adjustments
- External adjustable relief valves on F and G range models
- Hydrogen models have ventable relief valves (J Series does not)
- Sintered inlet filter – bronze

#### DIMENSIONS

6" W x 6.5" H x 6.25" D (152.4 mm x 165.1 mm x 158.8 mm)

#### WEIGHT

4 lb (1.81 kg)

#### PERFORMANCE

- Maximum Inlet
  - 7500 psig with CGA 677
  - 6000 psig without inlet fitting
  - 5500 psig with CGA 701, 680, 347
  - 4000 psig with CGA 577
  - 3000 psig with CGA 540, 580, 346, 350

#### PANEL MOUNTING DETAILS

- All SR 4 Series regulator models may be panel mounted.
- (1.75" (44.5 mm) hole required in panel for mounting)
- For a flush panel mount installation order one panel mount nut 1409-0093. For an adjustable panel mount installation order two panel mount nuts 1409-0093.

#### SR 4 FLOW DATA

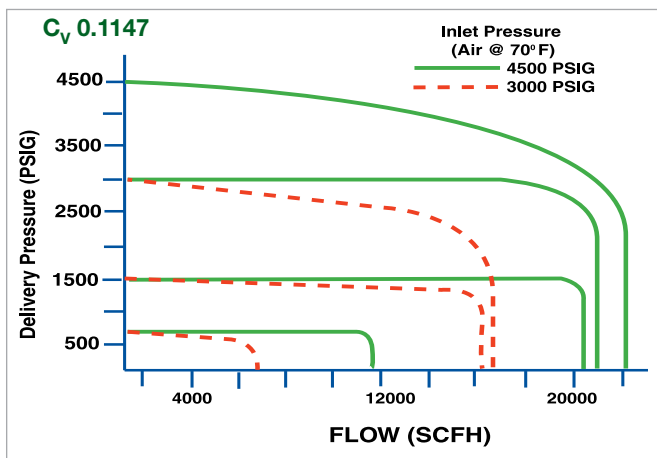

Gas Service	Part No.	Model No.	Delivery Range (psig)
Oxygen	0781-1405	SR 4F-540	50-750
	0781-1425	SR 4G-540	100-1500
	0781-1445	SR 4J-540	200-3000
	0781-1408	SR 4F-580	50-750
	0781-1410	SR 4F-680	50-750
Inert Gas	0781-1428	SR 4G-580	100-1500
	0781-1430	SR 4G-680	100-1500
	0781-1448	SR 4J-580	200-3000
	0781-1450	SR 4J-680	200-3000
	0781-1453	SR 4J-677	200-3000
	0781-1470	SR 4K-680	300-4500
	0781-1473	SR 4K-677	300-4500
	0781-1403	SR 4F-347	50-750
Air	0781-1422	SR 4G-346	100-1500
	0781-1442	SR 4J-346	200-3000
	0781-1463	SR 4K-347	300-4500
Methane, Hydrogen	0781-1404	SR 4F-350	50-750
	0781-1424	SR 4G-350	100-1500
CO <sub>2</sub>	0781-1444	SR 4J-350	200-3000
	0781-1401	SR 4F-320	50-750
Panel Mount 1/4" NPT Inlet	0781-1415	*SR 4PF-250	50-750
	0781-1420	*SR 4PG-250	100-1500
	0781-1455	*SR 4PJ-250	200-3000
	0781-1475	+SR 4PK-250	300-4500
Manifold High Pressure	0781-1454	SR 4TJ-996	200-3000

Inlet: \*1/4" NPT(F)  
 Outlet Fitting: 1/4" Swagelok type stainless steel.  
 +5/8"-20 UNF(M) inlet 1/8" NPT(F) outlet



## SR 600

### HEAVY DUTY

Single stage regulator designed for pressure testing and ideal where 350 or 550 psig (maximum) delivery pressures are needed, such as dead-end testing

#### DESIGN/CONSTRUCTION

- Forged brass body & housing cap
- 2.5" (63.5 mm) gauges
  - brass (6000 lb high pressure, 600 lb and 1000 lb low pressure)
- Cartridge type seat assembly with PCTFE seat
- Diaphragm --stainless steel
- External self-reseating relief valve
- CGA 540, 580, 346 have a maximum inlet pressure of 3000 psig



#### DIMENSIONS

7.5" W x 6" H x 5" D (190.5 mm x 152.4 mm x 127.0 mm)

#### WEIGHT

5 lb 7 oz (2.47 kg)

#### PERFORMANCE

- Maximum inlet – 5500 psig
- Outlet pressure ranges – 350 and 550 psig
- Inlet port – 5/8"-20 UNF(M)
- Outlet fitting – 1/4" Swagelok-brass
- Temperature operating range – 0-140°F

### SR 600 FLOW DATA

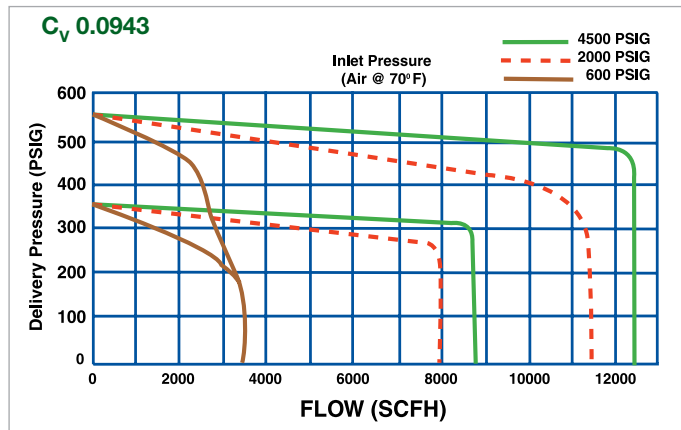

Gas Service	Part No.	Model No.	Delivery Range (psig)
Inert Gas	0781-1601	SR 600-350-580	5-350
High Pressure Inert Gas	0781-1604	SR 600-350-680	5-350
High Pressure Air	0781-1605	SR 600-350-347	5-350
Oxygen	0781-1610	SR 600-550-540	5-550
Inert Gas	0781-1611	SR 600-550-580	5-550

## MANIFOLD REGULATORS

### HEAVY DUTY

- Wide range of flow capabilities
- Wide range of pressure delivery
- Single and two stage models available



Gas Service	Part No.	Model No.	Delivery Range (psig)
<b>HIGH PRESSURE DELIVERY - PISTON</b>			
Air, Oxygen, Inert Gas, Hydrogen	0781-1457	SR 4MF-996	50-750
	0781-1437	SR 4MG-996	100-1500
	0781-1458	SR 4MJ-996	200-3000
	0781-1436	SR 4MF-997	50-750
	0781-1438	SR 4MG-997	100-1500
	0781-1456	SR 4MJ-997	200-3000
<b>SINGLE STAGE</b>			
Air, Oxygen, Inert Gas	0781-0611	SR 450MD-996	5-125
	0781-0612	SR 450ME-996	10-200
Methane, Hydrogen	0781-0613	SR 452MD-997	5-125
	0781-0615	SR 453MD-996	5-125
Acetylene	0781-0617	SR 460MA-997	2-15
L.P. Gas	0781-0618	SR 461MB-997	2-40
	0781-0619	SR 461MD-997	5-125
<b>EXTRA HIGH FLOW - SINGLE STAGE</b>			
Air, Oxygen, Inert Gas	0780-0797	SR 700MD-996	5-125
	0780-0798	SR 700ME-996	10-200
	0780-0809	SR 700MD-500	5-125
Methane, Hydrogen	0780-0803	SR 702ME-997	10-200
	0780-0804	SR 703MD-996	5-125
CO <sub>2</sub>	0780-0805	SR 703ME-996	10-200
Acetylene	0780-0806	SR 710MA-997	2-15
L.P. Gas	0780-0807	SR 711MB-997	2-40
<b>TWO STAGE</b>			
Methane, Hydrogen	0781-3961	VTS 452MD-997	5-125
	0781-3962	VTS 452ME-997	10-200
<b>TWO STAGE - HIGH FLOW</b>			
Air, Oxygen, Inert Gas	0780-0997	VTS 700MD-996	5-125
	0780-0998	VTS 700ME-996	10-200
CO <sub>2</sub>	0780-1004	VTS 703MD-996	5-125
	0780-1005	VTS 703ME-996	10-200
Acetylene	0780-1006	VTS 710MA-997	2-15
L.P. Gas	0780-1007	VTS 711MB-997	2-40

Inlet Connection: 1"-11.5 NPS(M)  
 Outlet Connections: 1"-11.5 NPS(F)

## EDGE™ SERIES

### INNOVATIVE EDGE™ SERIES REGULATORS OFFER SAFETY AND ADVANCED DESIGN

Victor® has been the leader in gas equipment for one hundred years, and its tradition of unparalleled safety remains a cornerstone of the brand today. With the Victor Professional EDGE Series Regulators, Victor continues to offer the safest, most reliable and highest quality gas control technology, giving you more value for your purchase. In addition, standardized designs and components throughout the EDGE family greatly simplify regulator service and repair. All EDGE Series Regulators are easy to use, durable and compact, designed for performance and unmatched for safety.

#### ADDITIONAL FEATURES

- 4 port forged brass body
- High strength zinc-aluminum housing cap
- 2.5" gauge with updated artwork
- Color-coded SLAM™ impact absorbing safety knob
- Meets or exceeds CGA E-4
- ETL listed to UL 252

#### EDGE ELC4 – LIQUID REGULATOR SERIES

The ELC4 Series brings the innovative features of the EDGE regulator to liquid cylinder use. This regulator is optimally designed to work with the vaporized gas from a liquid vessel.

#### EDGE ESL4 PIPELINE – LINE REGULATOR SERIES

Designed for gas distribution/pipeline systems, the ESL4 line regulator improves upon previous Victor® regulators with added EDGE benefits including the ergonomic, color coded adjusting knob and updated gauges.

#### EDGE EST4 PIPELINE – STATION REGULATOR SERIES

Ideal for weld station use and other gas distribution applications, the EST4 station regulator is fitted with the appropriate station style CGA connections for use with oxygen, inert or fuel gases. Along with the color coded adjusting knob and new gauges, this regulator not only improves productivity but looks good doing it.



<b>RED</b>	<b>GREEN</b>	<b>BLACK</b>	<b>GRAY</b>
Acetylene	Oxygen	Inert Gas	Carbon Dioxide

## ELC4

### LIQUID CYLINDER

#### DESIGN/CONSTRUCTION

- Stainless diaphragm
- Rear entry design

#### DIMENSIONS

3.8" W x 7.1" H X 8.2" L  
(96.5 mm x 180.3 mm x 208.3 mm)

#### WEIGHT

4 lbs 5 oz (1.95 kg)

#### PERFORMANCE

Maximum inlet –  
3000 psig



#### ELC4 FLOW DATA - EDGE Series-Liquid Cylinder

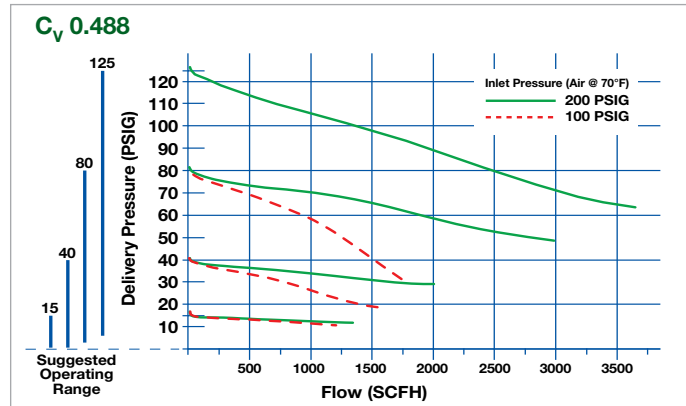

Gas Service	Part No.	Model No.	Delivery Range (psig)
Oxygen	0781-5199	ELC4-125-540R	5-125
Inert (Nitrogen, Argon, Helium)	0781-5200	ELC4-125-580R	5-125
	0781-5202	ELC4-325-580R	5-325
Carbon Dioxide	0781-5201	ELC4-125-320R	5-125

# ESL4

## LINE REGULATOR

### DESIGN/CONSTRUCTION

- Versatile – supports a variety of inlet pressures (up to 3000 psig)

### DIMENSIONS

3.8" W x 7.1" H X 8.2" L  
(96.5 mm x 180.3 mm x 208.3 mm)

### WEIGHT

4 lbs 5 oz (1.95 kg)

### PERFORMANCE

Maximum inlet – 3000 psig



# EST4

## STATION REGULATOR

### DESIGN/CONSTRUCTION

- Side entry and rear entry inlet versions available

### DIMENSIONS

3.8" W x 7.1" H X 8.2" L  
(96.5 mm x 180.3 mm x 208.3 mm)

### WEIGHT

4 lbs 5 oz (1.95 kg)

### PERFORMANCE

Maximum inlet – 200 psig



REGULATORS

ESL4 FLOW DATA - EDGE Series-Line

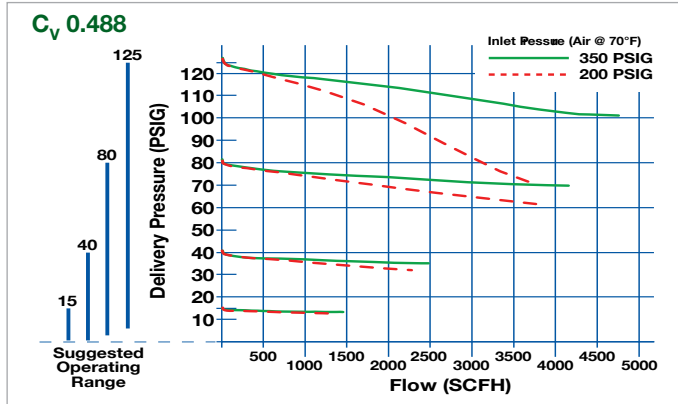

Gas Service	Part No.	Model No.	Delivery Range (psig)
Air, Inert Gas, Carbon Dioxide, Nitrous Oxide	0781-5190	ESL4-125-250	5-125
Oxygen	0781-5214	ESL4-125-250X	5-125
Hydrogen, Methane, Natural Gas, L.P. Gas	0781-5210	ESL4-80-250F	4-80
	0781-5211	ESL4-125-250F	5-125
Acetylene	0781-5208	ESL4-15-250A	2-15

EST4 FLOW DATA - EDGE Series-Station

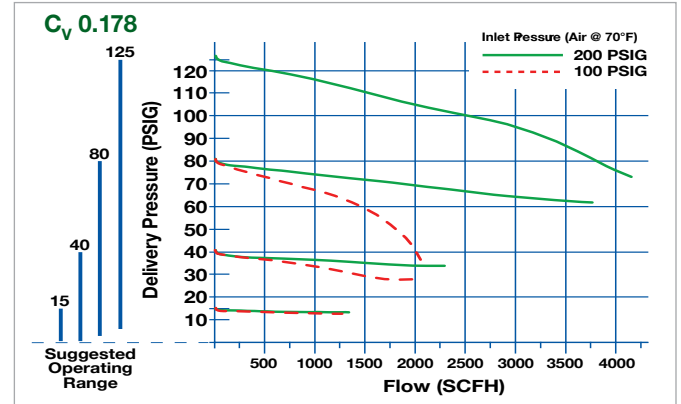

Gas Service	Part No.	Model No.	Delivery Range (psig)
Oxygen	0781-5191	EST4-40-024	2-40
	0781-5204	EST4-40-024R	2-40
	0781-5192	EST4-80-024	4-80
	0781-5205	EST4-80-024R	4-80
	0781-5193	EST4-125-024	5-125
	0781-5206	EST4-125-024R	5-125
Inert (Nitrogen, Argon, Helium)	0781-5189	EST4-125-034	5-125
	0781-5207	EST4-125-034R	5-125
Acetylene	0781-5194	EST4-15-025	2-15
	0781-5209	EST4-15-025R	2-15
	0781-5195	EST4-80-025	4-80
Hydrogen, Methane, Natural Gas, L.P. Gas	0781-5212	EST4-80-025R	4-80
	0781-5196	EST4-125-025	5-125
	0781-5213	EST4-125-025R	5-125

## PIPELINE DEVICES

- L 700 HIGH FLOW LINE
- DL 700 DOME LOAD LINE
- BSL 7000 BULK SYSTEM LINE

Victor offers high performance products for non-cylinder applications such as automated cutting, bulk gas system delivery and other pipeline applications where high flow and maintaining consistent delivery pressure is critical.

**NOT DESIGNED FOR USE ON CYLINDERS**

REGULATORS

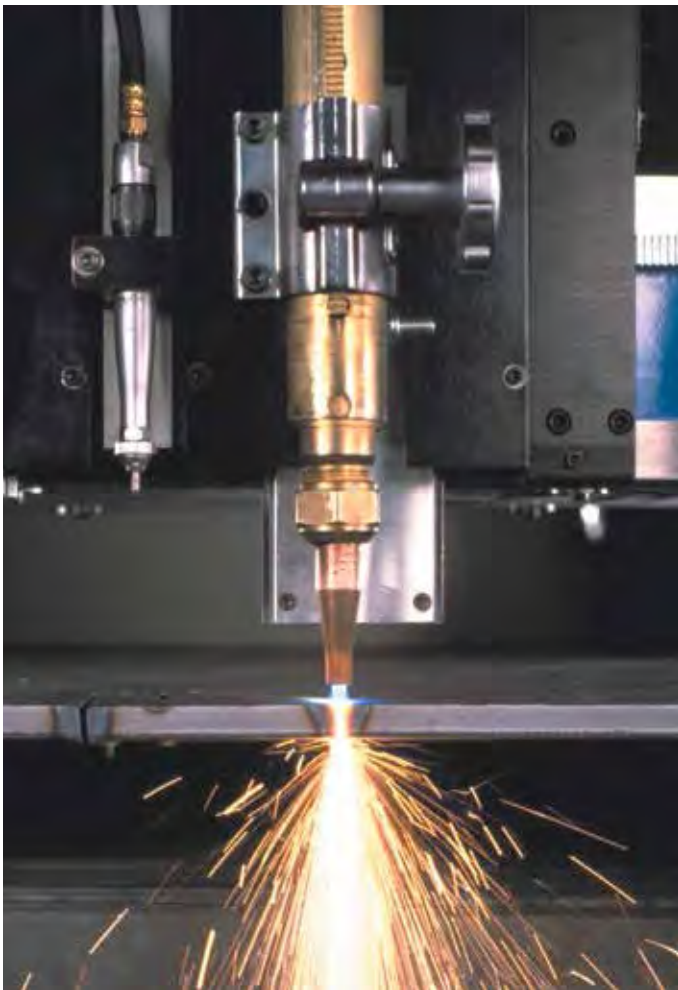

## L 700

### HIGH FLOW LINE

#### DESIGN/CONSTRUCTION

- Forged brass body & housing cap
- 2.5" (63.5 mm) gauge – brass
- Stem type seat mechanism
- 3.25" (82.6 mm) diaphragm – fabric-reinforced neoprene
- Delrin cap bushing for smooth adjustments
- Designed for gas distribution system (pipeline)
- Available in either 1/2" NPT(F) or 3/4" NPT(F) inlet

#### DIMENSIONS

4" W x 7" H x 6" D  
(101.6 mm x 177.8 mm x 152.4 mm)

#### WEIGHT

4 lb 15 oz (2.4 kg)



**WARNING:** Maximum inlet pressure 350 psig. Not for use on cylinders.

### L 700 FLOW DATA

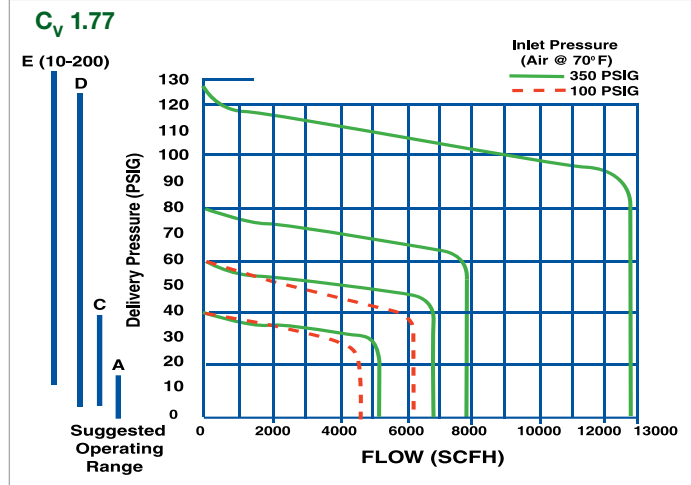

Gas Service	Part No.	Model No.	Delivery Range (psig)	Inlet & Outlet Ports
Air, Oxygen, Inert Gas	0780-1229	L 700C-500	4-80	1/2" NPT(F)
	0780-1220	L 700C-750	4-80	3/4" NPT(F)
	0780-1207	L 700D-500	5-125	1/2" NPT(F)
	0780-1236	L 700D-500 PMT*	5-125	1/2" NPT(F)
	0780-1209	L 700D-750	5-125	3/4" NPT(F)
	0780-1221	L 700E-500	10-200	1/2" NPT(F)
Acetylene	0780-1222	L 700E-750	10-200	3/4" NPT(F)
	0780-1233	L 710A-500	2-15	1/2" NPT(F)
Hydrogen, L.P. Gas	0780-1201	L 710A-750	2-15	3/4" NPT(F)
	0780-1199	L 711D-500	5-125	1/2" NPT(F)

\*PMT Panel Mount

## DL 700

### DOME LOAD LINE

#### DESIGN/CONSTRUCTION

- Forged brass body & housing cap
- Stem type seat mechanism – fabric reinforced neoprene
- 1/2" NPT(F) inlet & outlet ports
- Externally dome loaded
- Remotely controlled pressure adjustment
- Designed for cutting machines or applications that demand very consistent delivery pressures
- The DL 700 line regulator is externally dome loaded for remote control of gases.
- The delivery pressure on the DL 700 is controlled by the pressure supplied from a remote pilot regulator



#### DIMENSIONS

3.75" W x 4" H x 5.63" D  
(95.3 mm x 101.6 mm x 143.0 mm)

#### WEIGHT

4 lb 8 oz (2.04 kg)

#### PERFORMANCE

- Maximum inlet – 500 psig
- Maximum outlet – 125 psig
- Temperature operating range – 0-140° F
- Dome load inlet size – 1/4" NPT(F)
- Maximum dome load pressure – 125 psig

**WARNING:** Not for use on cylinders.

### DL 700 FLOW VS OUTLET PRESSURE

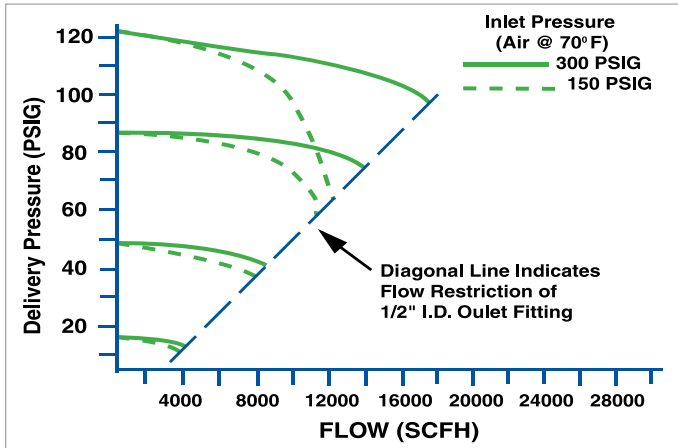

Gas Service	Part No.	Model No.	Delivery Range (psig)
A wide range of gases	0780-1188	DL 700	5-125
Connections: 1/2" NPT(F) Inlet & Outlet Ports			

## BSL 700

### BULK SYSTEM LINE

#### DESIGN/CONSTRUCTION

- Forged brass body & housing cap
- 2.5" (63.5 mm) gauge – brass
- Stem type seat mechanism
- 3.25" (82.6 mm) diaphragm – stainless steel
- Bleed valve in low pressure port
- Nozzle – brass
- Seat return spring – stainless steel
- Seals – silicon and nylon
- Designed for downstream vapor applications
- Ideal for bulk system installations
- Durable and will withstand most environmental situations
- Inlet pressure up to 350 psig



#### DIMENSIONS

3.25" W x 8.5" H x 7.5" D  
(82.6 mm x 215.9 mm x 190.5 mm)

#### WEIGHT

5 lb 8 oz (2.49 kg)

#### PERFORMANCE

- Maximum inlet – 350 psig
- Outlet range – 10-200 psig
- Temperature operating range 0-140° F

**WARNING:** Maximum inlet pressure 350 psig. Not for use on cylinders.

### BSL 700 FLOW VS OUTLET PRESSURE

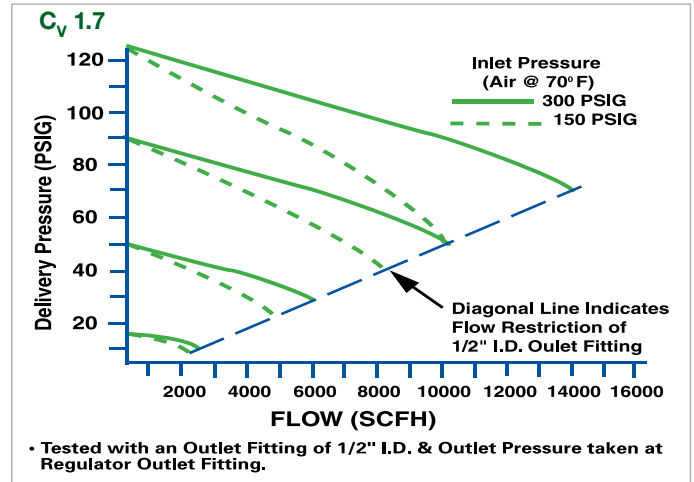

• Tested with an Outlet Fitting of 1/2" I.D. & Outlet Pressure taken at Regulator Outlet Fitting.

Gas Service	Part No.	Model No.	Delivery Range (psig)	Outlet Gauge (psig)	Inlet & Outlet Ports
Oxygen, Inert Gas	0780-1200	BSL 700	10-200	0-400	1/2" NPT(F)

## FLOW PRODUCTS

### WHAT DOES VICTOR HAVE TO OFFER?

Victor® has a full line of flow products for virtually any application. Whether it is welding, industrial or laboratory use, Victor has a flow meter, flow gauge or surge limiting regulator for your needs.

Victor offers a range of products for the delivery of shielding gas in the arc welding process or any application where gas flow rates, versus delivery pressure, are the primary consideration. These products are available for pure or mixed gases and for working with either high pressure cylinders or low pressure "piped shop" environments.

#### OFFERING INCLUDES:

- Regulators with flow meter
- Flow Meters
- Flow Gauge Regulators
- Single or Two Stage designs
- Surge limiting regulator

REGULATORS



## ESS3-FG

### FLOW GAUGE

#### DESIGN/CONSTRUCTION

- Forged brass body
- Zinc-Aluminum housing cap
- High impact ABS gauge guard
- 1.5" (40 mm) gauges - brass
- Stem type seat mechanism
- 2" (50.8 mm) diaphragm - fabric reinforced neoprene
- External self reseating relief valve. Not designed to protect downstream equipment
- Sintered inlet filter - nickel plated bronze
- SLAM™ impact absorbing safety knob
- Meets or exceeds CGA E-4, UL 252 and ASTM G-175 Promoted Ignition Test

#### DIMENSIONS

6.6" W x 4.4" H x 3.6" D  
(167.6 mm x 111.8 mm x 91.4 mm)

#### WEIGHT

3.5 lb (1.59 kg)

#### PERFORMANCE

- Maximum inlet - 3000 psig
- Flow Range - 0-40 CFH (0 - 19 L/min.)



**BLACK** Inert Gas  
**GRAY** Carbon Dioxide

Gas Service	Part No.	Model No.	Flow Range (SCFH)
Argon	0781-5120	ESS3-FG-580	0-40
Carbon Dioxide	0781-5119	ESS3-FG-320	0-40

Outlet Connections: 5/8"-18 RH(F), CGA 032

# SR 310, SR 311, & SR 312

## FLOW METER

### DESIGN/CONSTRUCTION

- Designed for CO<sub>2</sub> application (non-siphoned tube cylinders)
- High flow CO<sub>2</sub> applications (SR 310 100 psig) (SR 311/312 100 SCFH) with adequate supply or source
- Designed for core wire applications
- Machined aluminum body & housing cap
- 2" (50.8 mm) gauge
- Stem type seat mechanism
- 1.75" (44.5 mm) diaphragm - fabric reinforced neoprene
- Self reseating relief valve (not designed to protect downstream equipment)
- Sintered inlet filter - bronze

### DIMENSIONS

8.38" W x 7.25" H x 2.5" D  
(212.9 mm x 184.2 mm x 63.5 mm)

### WEIGHT

2 lb 15 oz (1.33 kg)

### PERFORMANCE

- Maximum inlet – 1500 psig
- Delivery range – 100 SCFH

A regulator equipped with a flow gauge is not accurate when a back pressure in excess of 2 psig exists at the outlet. Back pressure is caused by a restriction in the equipment downstream of the flow gauge. Metering valves, kinked hoses or even very long hoses are restrictions that can cause back pressure. In applications where back pressure in excess of 2 psig can be expected, a regulator equipped with a flow meter should be used.

**WARNING:** High gas withdrawal rates may cause regulator freeze up and will require cylinder manifolding. Consult your gas supplier. See below for Gas Heater.



REGULATORS

Gas Service	Part No.	Model No.	Flow Range	CGA Inlet Connection
Carbon Dioxide	0781-0355	SR 310 Adjustable Pressure Gauge	10-200 psig	320
	0781-0353	SR 311 (Preset @ 80 psig) Flow Meter	25-100 SCFH	320
	0781-0354	SR 312 Flow Gauge	0-100 SCFH	320

Outlet Connections: 5/8"-18 RH(F)  
Adapter: 5/8"-18(M) x 1/4" NPT(M) (Part No. 0950-0163)



## GAS HEATER

Manufactured for either Carbon Dioxide (CO<sub>2</sub>) or Nitrous Oxide (N<sub>2</sub>O). These heaters operate on 110 Volts at 120 Watts (1 Amp). They are thermostatically controlled at 160°F (+5°) and rated for flows up to 160 SCFH. Rated for standard cylinder pressures up to 3000 psi.

Part No.	Description	Weight
5370-7141	Electric CO <sub>2</sub> Heater	2 lb 0.9kg
5370-7142	Electric N <sub>2</sub> O Heater	2 lb 0.9kg

## SLR 100

### SURGE LIMITING REGULATOR

For use with Shielding Gas

#### DESIGN/CONSTRUCTION

- Reduces gas surge at the application of the torch/gun
- Provides a more consistent flow rate of shielding gas to welding machines
- All brass construction
- Neoprene diaphragm
- 50 micron sintered bronze internal filter

#### PERFORMANCE

- Recommended inlet pressure: 100± 20 psig (200 max)
- Flow: 50 SCFH (preset)
- Connections: CGA 032 RH



Gas Service	Model No.	CGA Inlet Connection	Part No.
Inert	SLR 100	032	0781-1197
Outlet Connections: Inlet 5/8" - 18 RH(F) Outlet 5/8" - 18 RH(M)			

REGULATORS

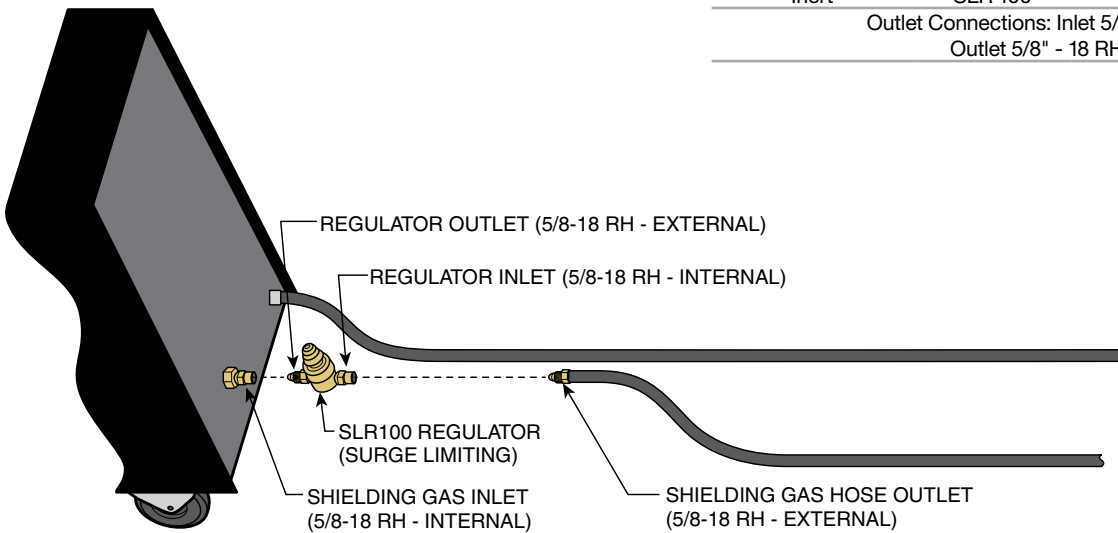

### WHAT DOES BACK PRESSURE COMPENSATION MEAN?

When a flow meter is back pressure compensated, it is not affected by any downstream restrictions that result in a pressure buildup. In a device that is not compensated, the back pressure will result in inaccurate readings on the flow tube or gauge.

All Victor FM Series flow meters are back pressure compensated to ensure accurate reading at all times, even if line restrictions are present.

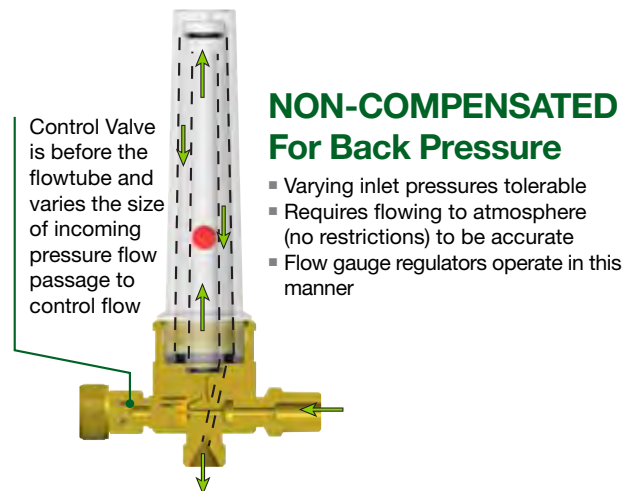
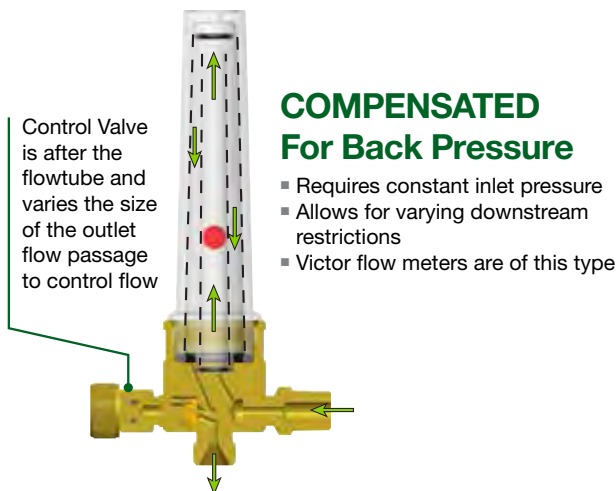



# FLOW METER

## HEAVY DUTY

### DESIGN/CONSTRUCTION

- Gas flow measurement in SCFH
- MIG / TIG applications
- Flowtube and outer tube are made of impact resistant lexan for severe applications
- Pressure compensated for low surge requirement
- Cover tube contains overpressure protection

All Victor flow meters are back pressure compensated to ensure accurate readings at all times, even if line restrictions are present. All flow meters are calibrated to operate at 25 psig inlet pressure to minimize surge, except the FM 200 which is calibrated to operate at 80 psig.

**WARNING:** Not designed for cylinder use.  
Do not exceed calibrated inlet pressure.



FM372

REGULATORS

Part No.	Model No.	Flow Range (SCFH)	Inlet Fitting	Outlet Fitting	Replacement Flow Tube	Inlet Pressure (psig)
<b>UNITS WITH SINGLE GAS CALIBRATION</b>						
1000-0264	FM 200	30-100 CO <sub>2</sub>	1/4" NPT(M)	5/8"-18 RH(F)	1015-0066	80
<b>UNITS WITH 2 GAS CALIBRATIONS</b>						
1000-0268	FM 150	10-60 Air, 10-60 Nitrogen	1/4" NPT(M)	5/8"-18 RH(F)	1015-0060	25
1000-0255	FM 135	4-18 Argon, 10-50 Helium	9/16"-18 RH(F)	5/8"-18 RH(F)	1015-0063	25
1000-0256	FM 145	4-18 Argon, 10-50 Helium	5/8"-18 RH(M)	5/8"-18 RH(F)	1015-0063	25
1000-0257	FM 155	4-18 Argon, 10-50 Helium	1/4" NPT(M)	5/8"-18 RH(F)	1015-0063	25
1000-0261	FM 137	15-65 Argon, 40-200 Helium	9/16"-18 RH(F)	5/8"-18 RH(F)	1015-0064	25
1000-0262	FM 147	15-70 Argon, 40-200 Helium	5/8"-18 RH(M)	5/8"-18 RH(F)	1015-0064	25
1000-0263	FM 157	15-65 Argon, 40-200 Helium	1/4" NPT(M)	5/8"-18 RH(F)	1015-0064	25
<b>UNITS WITH 3 GAS CALIBRATIONS</b>						
1000-0258	FM 370	5-40 CO <sub>2</sub> , 5-50 Argon, 20-150 Helium	9/16"-18 RH(F)	5/8"-18 RH(F)	1015-0057	25
1000-0259	FM 371	5-40 CO <sub>2</sub> , 5-50 Argon, 20-150 Helium	5/8"-18 RH(M)	5/8"-18 RH(F)	1015-0057	25
1000-0182	FM 372	5-40 CO <sub>2</sub> , 5-50 Argon, 20-150 Helium	1/4" NPT(M)	5/8"-18 RH(F)	1015-0057	25

**To ensure proper gas flow and to prevent tampering to your flowmeter use a Victor Locking Valve (Part No. 0662-0079)**

### HRF 2400

#### MEDIUM DUTY

##### DESIGN/CONSTRUCTION

- Regulator / flow meter combination in one compact unit
- MIG / TIG applications
- Ideal for all applications where dependability is needed
- Calibrated tube at 25 psig (not on HRF 2480)
- Machined brass body & housing cap
- Back pressure compensated
- Fabric reinforced neoprene diaphragm
- Internal self reseating relief valve – not designed to protect downstream equipment
- Sintered inlet filter – bronze
- Cover tube contains overpressure protection

##### DIMENSIONS

5.63" W x 8.25" H x 3" D  
(143.0 mm x 209.6 mm x 76.2 mm)

##### WEIGHT

2 lb 8 oz (1.13 kg)

##### PERFORMANCE

- Maximum inlet – 3000 psig
- Outlet pressure – preset
- HRF 2425 – 25 psig
- HRF 2480 – 80 psig

**WARNING:** High gas withdrawal rates on carbon dioxide may require cylinder manifolding. Consult your gas supplier.



REGULATORS

Gas Service	Part No.	Model No.	Flow Range (SCFH)	Specify CGA Inlet Connection	Replacement Flow Tube
Argon, Argon/Carbon Dioxide Mix, Helium	0781-2731	HRF 2425 Preset @ 25 psig	10-50 (Argon), 20-150 (Helium)	580	1015-0057
Carbon Dioxide, Carbon Dioxide Mix	0781-2727	HRF 2480 Preset @ 80 psig	10-38 (CO <sub>2</sub> )	320	1015-0058
	0781-2728	HRF 2480 Preset @ 80 psig	7.5-37.5 (Argon)	320, 580	

Outlet Connections: 5/8"-18 RH(F), CGA 032

### DFM 150

#### MEDIUM DUTY

##### DESIGN/CONSTRUCTION

- Designed to monitor two separate processes or gas flows
- Ideal for applications where shielding gas and back purge requirements are needed
- Designed to offer convenience for the maintenance and fabrication industries
- Brass body
- Teflon seat mechanism
- Sintered inlet filter – bronze
- Music wire – spring
- Piston – brass
- Cover tube – lexan

##### DIMENSIONS

5.5" W x 6.5" H x 5" D  
(139.7 mm x 165.1 mm x 127.0 mm)

##### WEIGHT

2 lb 9 oz (1.16 kg)

##### PERFORMANCE

- Maximum inlet – 3000 psig DFM 150
- 75 psig DFM 150S
- Outlet pressure – 25 psig (preset)
- Flow Capacity (See below)
- Flow meter shows actual flow



Gas Service	Part No.	Model No.	Flow Range (SCFH)	CGA Inlet Connection	Max Inlet (psig)	HP Gauge	Replacement Flow Tube
Argon, Helium	0781-1153	DFM 150-580	5-50 (Argon), 20-150 (Helium)	580	3000	0-4000	1015-0057
Argon, Argon / Carbon Dioxide Mix, Helium Low Pressure	0781-1206	DFM 150S	5-50 (Argon) 5-40 (Argon/CO <sub>2</sub> ) 20-150 (Helium)	1/4" NPT (F)	75	0-100	1015-0057

Outlet Connection: 5/8"-18 RH(F), CGA 032  
Preset Pressure: 25 psig

## HSR & HVTS

### MEDIUM DUTY

#### DESIGN/CONSTRUCTION

- Single or two stage design
- Compact in size
- Accurate regulator for gas flow
- MIG / TIG applications
- Two stage version provides extremely accurate flow rates as cylinder pressure declines
- Low surge rates – 25 psi preset

#### HSR MODELS (SINGLE STAGE)

##### DIMENSIONS

7" W x 6.25" H x 4.25" D (177.8 mm x 158.8 mm x 108.0 mm)

##### WEIGHT

3 lb 3 oz (1.45 kg)

#### HVTS MODELS (TWO STAGE)

##### DIMENSIONS

7" W x 5.5" H x 6.5" D (177.8 mm x 139.7 mm x 165.1 mm)

##### WEIGHT

4 lb 10 oz (2.10 kg)

#### DESIGN/CONSTRUCTION

- Forged brass body and housing cap
- 2" (50.8 mm) high pressure gauge
- Stem type seat mechanism
- Fabric reinforced neoprene diaphragm
- External self reseating relief valve (not designed to protect downstream equipment)
- Sintered inlet filter – bronze

#### PERFORMANCE

- Maximum inlet – 3000 psig
- Outlet pressure – 25 psig (preset), 80 psig on CO<sub>2</sub>
- Flow capacity (See below)



**WARNING:** High gas withdrawal rates on carbon dioxide may require cylinder manifolding. Consult your gas supplier.

REGULATORS

Gas Service	Part No.	Model No.	Flow Range (SCFH)	Specify CGA Inlet Connection	Replacement Flow Tube	Gas Calibrations
Nitrogen/Air	0781-3819	*HSR 2530	10-60	580	1015-0070	2
	0781-3867	*HSR 2535	4-18 / 10-50	580	-	2
Argon/Helium	0781-3775	*HVTS 2535	4-18 / 10-50	580	-	2
	0781-3871	*HSR 2537	15-65 / 40-200	580	1015-0064	2
	0781-3772	*HVTS 2537	15-65 / 40-200	580	1015-0064	2
	0781-3873	*HSR 2570	5-50	580	1015-0057	3
Argon, Argon/Carbon Dioxide Mix, Helium	0781-3869	*HSR 2570	5-40	580	1015-0057	3
	0781-3774	*HVTS 2570	20-150	580	1015-0057	3
Hydrogen	0781-3825	HSR 2533	5-40	350	1015-0070	2
Argon, Argon/Carbon Dioxide Mix, Helium (Max Inlet – 200 psig)	0781-1245	S2570	5-50, 5-40, 20-140	034	1015-0057	3
Inert	0781-3880	HSR 1470-680	50-140-40	680	1015-0057	AR-HE-CO <sub>2</sub>

\*Outlet Connections: 5/8"-18 RH(F)

## HRF 1400

### LIGHT DUTY

#### DESIGN/CONSTRUCTION

- Regulator / Flow meter
- Single stage piston design
- Argon, Argon/CO<sub>2</sub> mix & CO<sub>2</sub> models
- 25 psig or 80 psig pre-set pressure
- Up to 50 CFH for Argon and up to 38 CFH for CO<sub>2</sub> delivery
- Available in CGA 320 & 580 inlet connections
- Optional MIG kit available with 10' (3.1 m) hose



#### WEIGHT

2.0 lb (0.91 kg)

#### PERFORMANCE

Maximum inlet pressure: 3000 psig

Outlet pressure: preset HRF 1425 – 25 psig HRF 1480 – 80 psig

Part No.	Model No.
0781-2723	HRF 1425-580
0387-0240	HRF 1425-580 CS
0781-2743	HRF 1425-580 (With 10' (3.1 m) hose)
0781-2725	HRF 1480-320
0781-2745	HRF 1480-320 (With 10' (3.1 m) hose)
0781-2724	HRF 1480-580
0781-2744	HRF 1480-580 (With 10' (3.1 m) hose)

Outlet Connection: 5/8"-18 RH(F)

CS = Clamshell Package

## TPR 250 PURGING REGULATOR

### LIGHT DUTY

#### DESIGN/CONSTRUCTION

- Single stage design
- Forged brass body & housing cap
- 2" (50.8 mm) gauges
- Stem type seat mechanism
- Neoprene diaphragm



#### DIMENSIONS

6.38" W x 5.13" H x 4.25" D  
(162.1 mm x 130.3 mm x 108.0 mm)

#### WEIGHT

2 lb 15 oz (1.33 kg)

#### PERFORMANCE

Maximum inlet pressure: 3000 psig

Part No.	Model No.	Delivery Pressure (psig)
0781-9133	TPR 250-125-580 CS	5-125
0781-9127	TPR 250-125-320	5-125
0781-9134	TPR 250-200-580 CS	10-250
0781-9135	TPR 250-500-580 CS	10-250

Outlet Connection: 1/4"-37° flare.

CS = Clamshell Package

## MECO HIGH PRESSURE

#### DESIGN/CONSTRUCTION

- Single-stage design
- Heavy-duty applications such as oil/gas industry
- Stainless steel diaphragm
- Positive pressure yoke type regulator
- Multi-seat 4 way seat block



#### WEIGHT

4 lb 9 oz (2.2 kg)

#### PERFORMANCE

- Maximum inlet pressure – 5500 psig
- Available as a preset model or with adjusting T-screw

Part Number	Description	Adjusting Mechanism	Pressure	Inlet
5641-8461	P Regulator 125 psi	Cap nut	125	1/4 -18 NPT
5641-8464	P Regulator 150 psi	T screw	150	1/4 -18 NPT
5641-8465	P Regulator 150 psi	Cap nut	150	1/4 -18 NPT
5641-8470	P Regulator 225 psi	T screw	225	1/4 -18 NPT
5641-8468	P Regulator 225 psi	T screw	225	1/4 -18 NPT



# HANDLES AND CUTTING ATTACHMENTS

## DESIGN AND CONSTRUCTION FEATURES

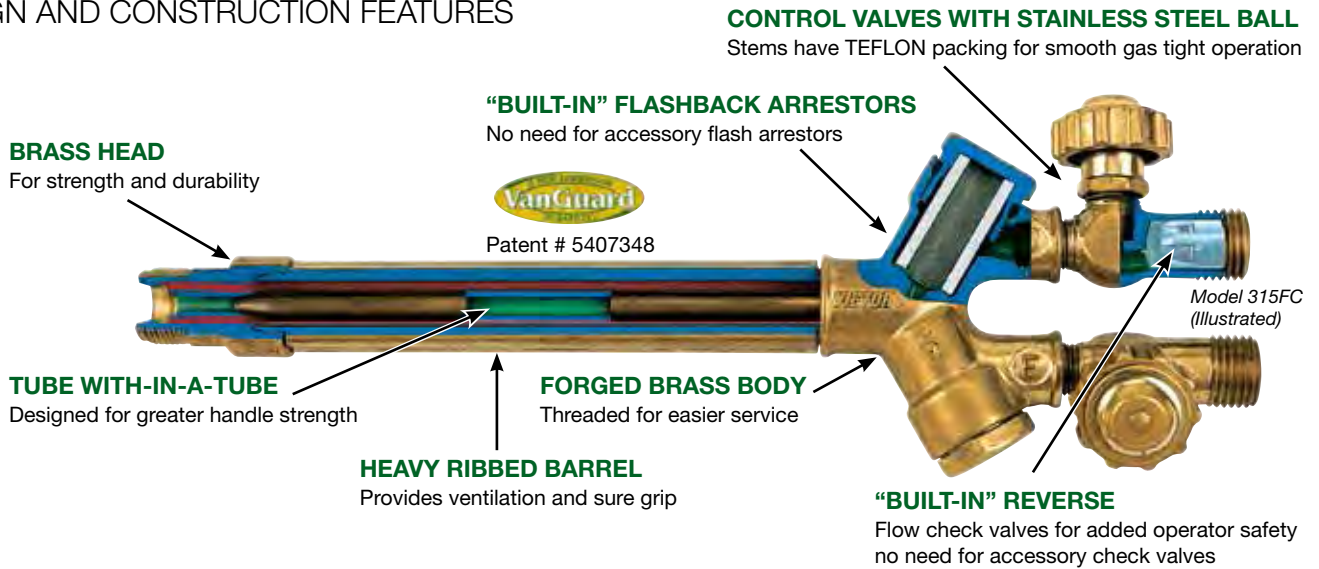

## RUGGED, EFFICIENT DESIGN - THREADED ASSEMBLY FOR EASE OF SERVICE

### VICTOR TORCH HANDLES GIVE YOU TWICE THE VALUE

Each torch handle is designed and built to withstand rugged job site conditions. In case of damage, Victor's threaded assembly design lets you replace parts quickly and economically.

### PERFORMANCE PROVEN TUBE-WITHIN-A-TUBE DESIGN

Victor torch handles include one oxygen tube within a massive, heavy ribbed handle which also serves as the gas tube. The result is greater strength and durability plus a reduction in overall size and weight for ease of operation.

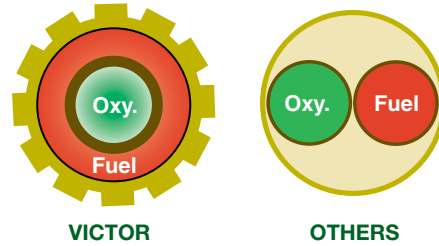
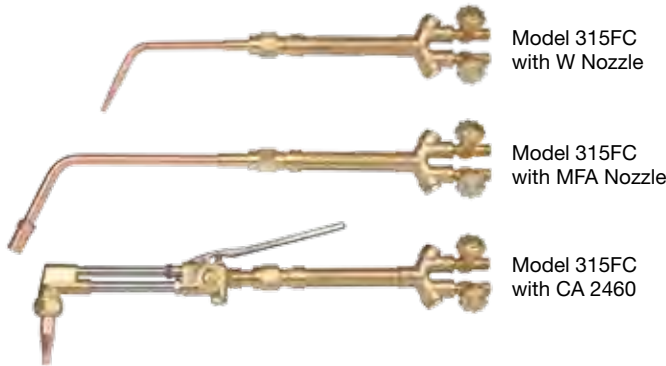

### VICTOR TUBE-WITHIN-A-TUBE DESIGN

Victor torch handles have greater wall thickness than other designs.

## COMPACT BALANCED ATTACHMENTS:

For cutting or heating. Each torch handle is designed for optimal balance and feel with its own nozzles and attachments. With proper balance of length and weight, operator fatigue is minimized.

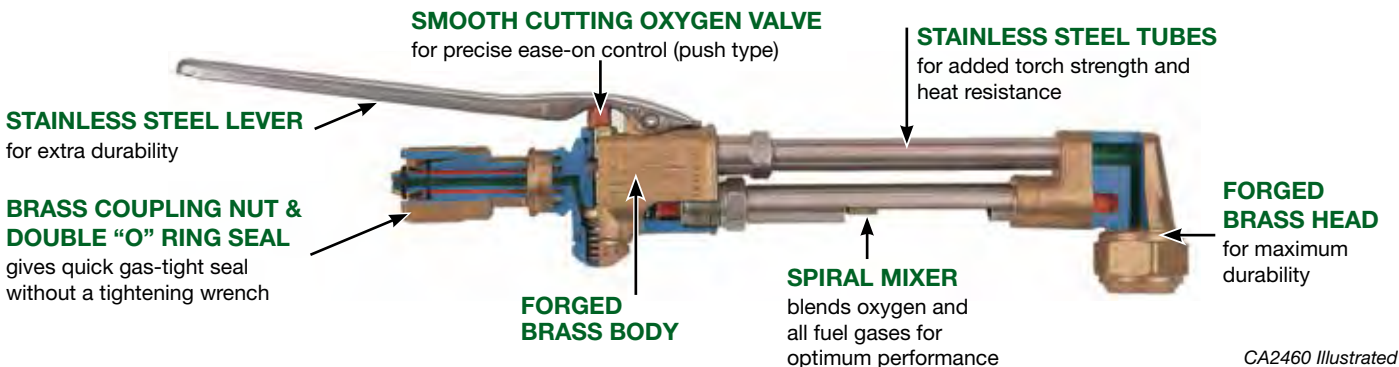

HANDLES & ATTACHMENTS

## 400 Series

### WH 411C TORCH HANDLE

HEAVY DUTY



- Accepts CA411-3 & CA411-1 Cutting Attachments, W Series Welding Tips and MFA/MFN/Type55 Heating Assemblies
- 5 Year Warranty

#### SPECIAL DESIGNED ALLOY MATERIAL:

- 3x the tensile strength of Brass
- Ergonomic, textured, precision contoured handle is designed to reduce operator fatigue and provide better grip
- Durable to withstand tough use and prevention of dents and scratches

#### INTUITIVE KNOBS:

- Color coded
- Clearly marked lettering with increase/decrease label
- Understandable in any language

Part No.	Model No.	Hose Connection	Gas	Weight	Length
0382-0355	WH 411C	"B" 9/16"-18 (CGA 022 & 023)	All		

### CA 411-1 CUTTING ATTACHMENT

HEAVY DUTY



(for use with all fuel gases)

### CA 411-3 CUTTING ATTACHMENT

MEDIUM DUTY



(for use with all fuel gases with appropriate tip)

Performance matched for each torch handle series.

- Efficient Universal Spiral Head Mixer
- 1 Cutting Attachment for All Fuel Gases
- Redesigned inlet nut increases grip for Hand Tightening
- Inline stainless tubes for better visibility
- Improved Stainless Lever provides increased comfort and reduced operator hand fatigue
- 5 Year Warranty

Part No.	Model No.	Cutting Range	Tip Series	Head Angle
0381-1940	CA411-1	6" (152.4 mm)	1	90°
0381-1939	CA411-3	5" (127.0 mm)	3	90°

Heavy and medium duty cutting attachments for use with acetylene, propane, butane, liquid air fuel gas, natural gas (2 PSI & above) and propylene. Cutting attachment accepts all Victor Style Tips.

## 300 Series

### HD 310C TORCH HANDLE

VICTOR HEAVY INDUSTRY

Built tough to withstand rugged job site conditions. Threaded assembly permits economical repair if service is necessary. The HD 310C has "B" hose connections with built-in reverse flow check valves for added safety.

The HD 310C is compatible with high capacity heating nozzles and all Victor 300 Series equipment.

#### WELDING & CUTTING EQUIPMENT:



- MFA & MFN heating nozzles
- Type 55 high capacity heating nozzles
- CA 2460 cutting attachment
- W Series welding nozzles

#### WARNING: USE FLASHBACK ARRESTORS

Although built to Victor's quality and safety standards, due to the flow capacity requirements, flashback arrestors are not manufactured into this Victor heavy industry torch handle. To reduce the risk of personal injury, death and/or property damage, use sufficient capacity flashback arrestors with all Victor heavy industry torch products

Part No.	Model No.	Hose Connection	Gas	Weight	Length
0382-0015	HD 310C	"B" 9/16"-18 (CGA 022 & 023)	All	28 oz	11" (279.4 mm)

For best performance, use the following recommended equipment:

#### FLASHBACK ARRESTORS

Part No.	Model	Type
Oxygen: (Select one of the following)		
0657-0010	*FB-0	Torch Mount
0657-0014	FB-OR	Regulator Mount
Fuel: (Select one of the following)		
0657-0011	*FB-F	Torch Mount
0657-0015	FB-FR	Regulator Mount
Pair Packs		
0656-0001	*FB-1	Oxy/Fuel Torch Mount
0656-0004	FBR-1	Oxy/Fuel Regulator Mount

\*Torch mount models also protect the hose

## 300 Series

### H 315FC TORCH HANDLE

EXTRA HEAVY DUTY



### 315FC TORCH HANDLE

HEAVY DUTY



#### VICTOR® TORCH HANDLES ARE AVAILABLE WITH VANGUARD™ SAFETY FEATURES:

- Built-in flashback arrestors – no need for accessory flash arrestors
- Built-in reverse flow check valves – no need for accessory check valves
- Works with all fuel gases. There are pressure restrictions for different gases

VanGuard torch handles are offered in extra heavy duty (H 315FC), heavy duty (315FC) and medium duty (100FC) models, and available in Victor's most popular system models. VanGuard torch handles also feature Victor traditional threaded assemblies for economical repair if service is necessary.

Part No.	Model No.	Description	Hose Connection	Gas	Weight	Length
0382-0316	H 315FC	High Flow Torch Handle	9/16"-18	All	20 oz	9" (228.6 mm)
0382-0034	315FC	"VanGuard" Heavy Duty	9/16"-18	All	18 oz	9" (228.6 mm)
0387-0008	315FC	"VanGuard" Heavy Duty (Clamshell)	9/16"-18	All	18 oz	9" (228.6 mm)

### 320 TORCH EXTENSION



Part No.	Description	Hose Connection	Gas	Weight	Length
0382-0019	320 Torch Extension	9/16"-18	All	16 oz	12" (304.9 mm)

## 300 Series

### CA 2460 CUTTING ATTACHMENT

HEAVY DUTY

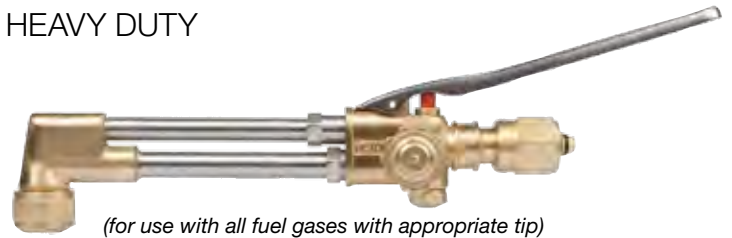

Performance matched for each torch handle series

- Forged brass head
- Spiral mixer blends oxygen & fuel
- Smooth cutting valve (push type)
- Stainless steel tubes
- Brass coupling nut & double "O" ring tapered seal gives quick gas-tight seal without a tightening wrench
- Length 10.5" (266.7 mm)
- Weight 32 oz (0.91 kg)

Part No.	Model No.	Cutting Range	Tip Series	Head Angle
0381-0816	CA 2460	8" (203.2 mm)	1	90°
0387-0000	CA 2460 CS	8" (203.2 mm)	1	90°
0381-0817	CA 2461	8" (203.2 mm)	1	75°
0381-0818	CA 2462	8" (203.2 mm)	1	180°
0381-0823	CA 2470	7" (177.8 mm)	3	90°

CS = Clamshell Package

### CHANGE THE TIP, NOT THE TORCH

#### ONE TORCH ALL FUELS

Switching from oxy-acetylene to oxy-propylene or other alternative gases requires changing the gas regulator and torch tips. A T-grade hose should be used with alternate fuels. Victor torches can easily accommodate any industrial fuel gas

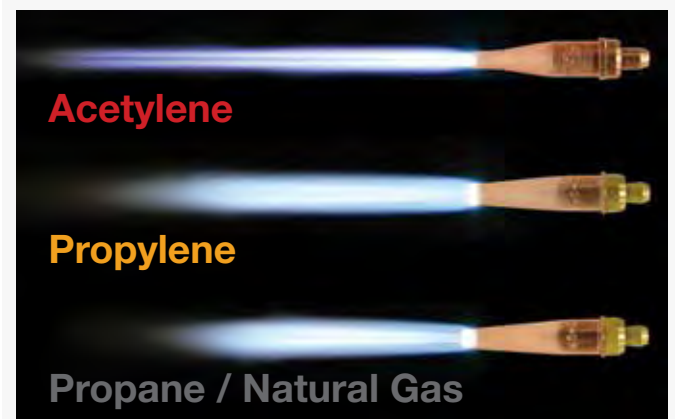

## 100 Series

### 100FC TORCH HANDLE

#### MEDIUM DUTY

Victor® torch handles cover the full range of welding, cutting and heating needs. Performance matched cutting attachments are available for each torch handle series. VanGuard™ handles include built-in flashback arrestors and reverse flow check valves.



#### VICTOR TORCH HANDLES ARE AVAILABLE WITH VANGUARD SAFETY FEATURES:

- Built-in flashback arrestors - no need for accessory flash arrestors
- Built-in reverse flow check valves - no need for accessory check valves
- Works with all fuel gases (pressure restrictions for different gases)

VanGuard torch handles are offered in extra heavy duty (H 315FC), heavy duty (315FC) and medium duty (100FC) models, and available in Victor's most popular system models. VanGuard torch handles also feature Victor traditional threaded assemblies for economical repair if service is necessary.

Part No.	Model No.	Description	Hose Connection	Gas	Weight	Length
0382-0032	100FC	"VanGuard" Medium Duty	9/16"-18	All	14 oz	8.5" (215.9 mm)
0387-0011	100FC	"VanGuard" Medium Duty (Clamshell)	9/16"-18	All	14 oz	8.5" (215.9 mm)

### CA 1350 CUTTING ATTACHMENT

#### MEDIUM DUTY

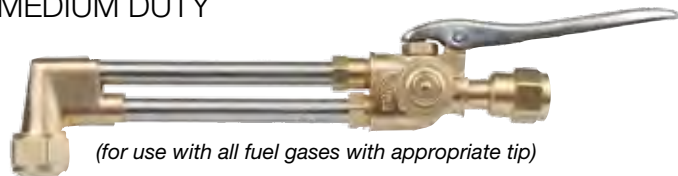

(for use with all fuel gases with appropriate tip)

Performance matched for each torch handle series.

- Forged brass head
- Spiral mixer blends oxygen & fuel
- Smooth cutting valve (pull type)
- Stainless steel tubes
- Brass coupling nut & double "O" ring seal gives quick gas-tight seal tightening with out wrench
- Length 8" (203.2 mm)
- Weight 13 oz (0.37 kg)

Part No.	Model No.	Cutting Range	Tip Series	Head Angle
0381-0418	CA 1350	6" (152.4 mm)	3	90°
0387-0005	CA 1350 CS	6" (152.4 mm)	3	90°
0381-0420	CA 1351	6" (152.4 mm)	3	75°
0381-0421	CA 1352	6" (152.4 mm)	3	180°

CS = Clamshell Package

## J Series

### J-28 & J-40 TORCH HANDLES

#### LIGHT DUTY

Victor torch handles cover the full range of welding, cutting and heating needs. Choose from patented standard models. Performance matched cutting attachments are available for each torch handle series.

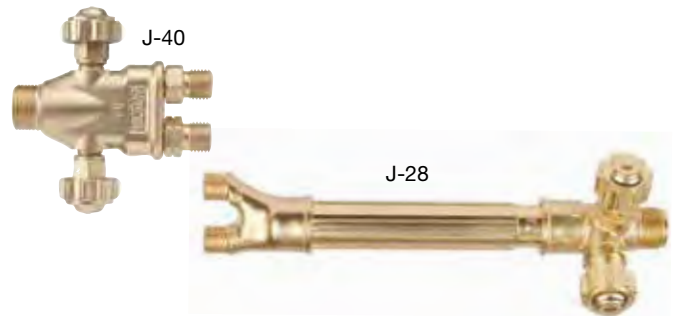

Part No.	Model No.	Description	Hose Connection	Gas	Weight	Length
0382-0006	J-40	Standard Light Duty	"A" Hose CGA 021/022	All	5.5 oz	3.75" (95.3 mm)
0382-0127	J-28	Light Duty	"A" Hose CGA 021/022	All	8.5 oz	6" (152.4 mm)

J-40 handle does not have check valves or flashback arrestors included  
J-28 handle includes accessory reverse flow check valves for regulator use

### CA 1260 CUTTING ATTACHMENT

#### LIGHT DUTY



(for use with all fuel gases with appropriate tip)

Performance matched for each torch handle series.

- Forged brass head
- Spiral mixer blends oxygen & fuel
- Smooth cutting valve (pull type)
- Stainless steel tubes
- Brass coupling nut & double "O" ring seal gives quick gas-tight seal tightening without wrench
- Length 8" (203.2 mm)
- Weight 13 oz (0.37 kg)

Part No.	Model No.	Cutting Range	Tip Series	Head Angle
0381-0162	CA 1260	3" (76.2 mm)	3	90°
0387-0003	CA 1260 CS	3" (76.2 mm)	3	90°

CS = Clamshell Package



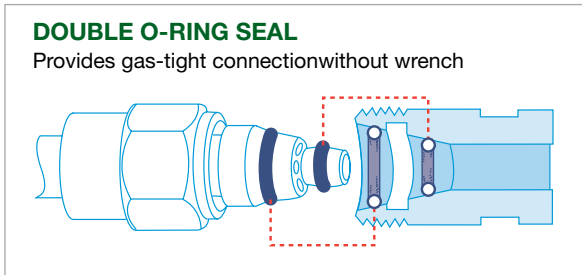

Flame orifice size the same for all nozzle series

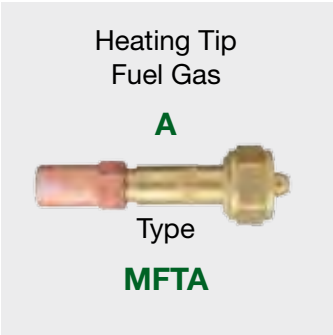
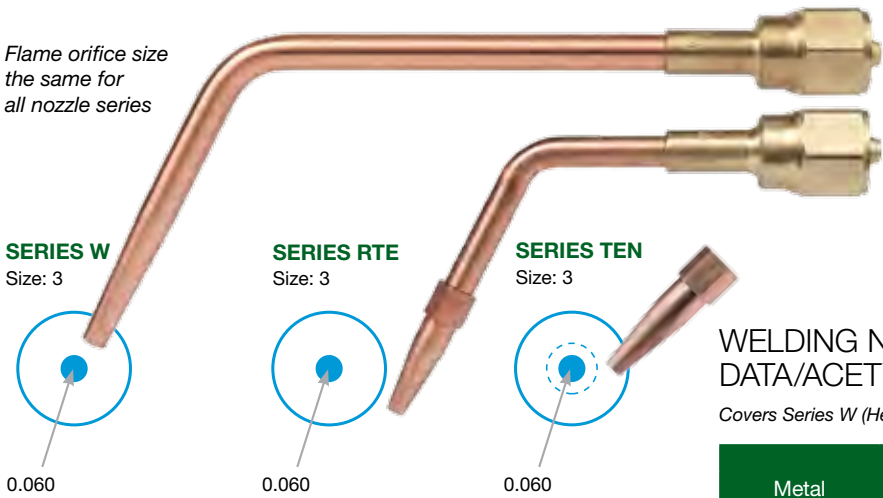

EXCLUSIVE "OPTIMIZED" NOZZLES WITH A LARGE CHOICE OF TYPES AND SIZES, PLUS UNIFORMITY OF TIP ORIFICE AND SIZE FOR ALL SERIES

**VICTOR OFFERS A COMPLETE RANGE OF NOZZLES,** tips and elbows with a size for every application including: welding, brazing, heating, descaling, hard facing, flame priming, etc.

**NOZZLES DESIGNED FOR "OPTIMUM" PERFORMANCE**  
Each complete nozzle has its own built-in spiral mixer, individually designed for each tip size and flame characteristic. Each nozzle is individually swaged to insure proper alignment for uniform flame, sizing and free-flow contour.

**ORIFICE SIZES ARE COMMON FOR ALL SERIES**  
Regardless of nozzle series (W, W-1, W-J), flame characteristic or fuel gas used. The uniformity of orifice sizes simplifies nozzle selection, eliminates chances of ordering and wrong size when changing from one type of nozzle to another.

**WELDING NOZZLE OPERATIONAL DATA/ACETYLENE**

Covers Series W (Heavy Duty), W-1 (Medium Duty) And W-J (Light Duty) Series

Operational & Performance Data						
Metal Thickness	Tip Size	Drill Size	Oxygen (psig)	Acetylene (psig)	Acetylene (Scfh)	
1/32" (0.8 mm)	000	75 (0.022)	3/5	3/5	1/2	
3/64" (1.2 mm)	00	70 (0.028)	3/5	3/5	1.5/3	
5/64" (1.9 mm)	0	65 (0.035)	3/5	3/5	2/4	
3/32" (2.4 mm)	1	60 (0.040)	3/5	3/5	3/6	
1/8" (3.2 mm)	2	56 (0.046)	3/5	3/5	5/10	
3/16" (4.8 mm)	3	53 (0.060)	4/7	3/6	8/18	
1/4" (6.4 mm)	4	49 (0.073)	5/10	4/7	10/25	
1/2" (12.7 mm)	5	43 (0.089)	6/12	5/8	15/35	
3/4" (19.0 mm)	6	36 (0.106)	7/14	6/9	25/45	
1 1/4" (32.0 mm)	7	30 (0.128)	8/16	8/10	30/60	
2" (51.0 mm)	8	29 (0.136)	10/19	9/12	35/75	
3" (76.2 mm)	10	27 (0.144)	12/24	12/15	50/100	

**WARNING:** At no time should the withdrawal rate of an individual acetylene cylinder exceed 1/7 of the cylinder contents per hour. If additional flow capacity is required use an acetylene manifold system of sufficient size to supply the necessary volume.

Oxygen consumption (SCFH) is 1.1 times the acetylene under neutral flame conditions.

Oxy-Acetylene & Oxy-Hydrogen				
Application	Torch Series	Nozzle Type	Available Sizes	Illustration
General purpose welding & heating. Uses replaceable tip ends. Flame characteristic – Long cone	315FC	RTE	000-6, 8, 10	
	H 315FC			
General purpose welding and preheating. Swaged one-piece copper elbow. Flame characteristic – Long cone	315FC	W	000-8, 10	
	100FC	W-1	000-7	
	J-28	W-J	000-4	
	J-40			

## TYPE 55/55-1 MULTI-FLAME HEATING NOZZLES

Use with 300, HD 310C Series Torch Handles

### VICTOR HEAVY INDUSTRY

The Type 55 Series multi-flame heating nozzles feature a raised center point on the head to prevent bumping the plate and compressing the flame. The center point and improved mixer design combine to provide greater resistance to sustained backfire and improved flow performance. Type 55s can be ordered as a complete assembly or as individual components.

- High capacity heating head for heat treating, straightening, and priming
- LP Gases

**WARNING: NOT FOR USE WITH ACETYLENE**

Part No.	Type	Available size	Available Length	Series
0323-0326	55	20*	28" (711.2 mm)	HD 310C
0323-0325	55	15*	28" (711.2 mm)	HD 310C
0323-0324	55	10*	28" (711.2 mm)	HD 310C
0323-0328	55	8	11" (279.4 mm)	HD 310C / 300
0323-0327	55	6	11" (279.4 mm)	300
0324-0188	55-1	6	11" (279.4 mm)	100

\*Size 10, 15 and 20 Type 55 heating nozzles must be used with HD 310C torch handle and 3/8" (9.5 mm) hose.

### TYPE 55 – FOR USE WITH PROPYLENE BASED FUEL GASES, METHANE, PROPANE, BUTANE, & PRESSURIZED NATURAL GAS

Tip Size	Oxygen Pressure (psig)	Fuel Pressure (psig)	Oxygen Consumption (SCFH)	Fuel Consumption (SCFH)	BTU Per Hour
20	100/150	30/50	900/1150	400/500	See Chart
15	90/120	20/35	600/800	250/350	
10	70/100	15/25	356/460	150/200	
8	70/85	15/25	220	85	
6	70/80	15/20	160	65	

### BTU PER HOUR

To approximate gross BTU output, multiply flow rate by BTU value listed below:

Propane	2498
Natural Gas	1000
Butane	3374
Propylene	2371

#### WARNING:

- Use flashback arrestors
- Although built to Victor's quality and safety standards, due to the cutting capacity and/or design of each torch, flashback arrestors are not manufactured into the 310C Series Victor heavy industry torches
- To reduce the risk of personal injury, death and/or property damage, use sufficient capacity flashback arrestors with all Victor heavy industry torch products
- Alternative fuel gas only refers to propane, natural gas, propylene gases. Acetylene, hydrogen and gasoline are NOT included as an alternative gas

## TYPE 55 COMPONENTS

### 300 SERIES

Type 55 Series multi-flames are available as components. Threaded elbows give you the flexibility to easily service or extend the length of the nozzles. Use the special extensions adapter to extend the tip tube to the required length.



**0328-0012 & 0328-0013**  
Mixer and Nut Assembly

**WARNING: NOT FOR USE WITH ACETYLENE**

Part No.	Available Size	Application/Description	Available Length	Available Angles	Series
0311-0232	20*	Multi-Flame Heads	-	-	HD 310C
0311-0231	15*	Multi-Flame Heads	-	-	HD 310C
0311-0230	10*	Multi-Flame Heads	-	-	HD 310C
0311-0241	8	Multi-Flame Heads	-	-	HD 310C / 300
0311-0240	6	Multi-Flame Heads	-	-	300
0304-0002	-	Multi-Flame Elbows	14" (355.6 mm)	65°	HD 310C / 300
0304-0095	-	Multi-Flame Elbows	16" (406.4 mm)	180°	HD 310C / 300
0304-0011	-	Multi-Flame Elbows	26" (660.4 mm)	65°	HD 310C / 300
0328-0012		Mixer and nut assembly, for use with pressures from 10 psig and up.			HD 310C / 300
0328-0013		Mixer and nut assembly, for use with pressures from 2 - 10 psig.			HD 310C / 300
0312-0064		Extension Adapter - Thread specifications: 1/4"- 18 NPT(F) X 1/2"- 27 UNS(F)"			HD 310C / 300

\*Size 10, 15 and 20 Type 55 heating nozzles must be used with HD 310C torch handle and 3/8" (9.5 mm) hose.



## MFN/MFN-1 HEATING NOZZLES

For Use with 100, 300 & HD310C Series Torch Handles

VICTOR HEAVY INDUSTRY

- Multi-flame heating head for preheating, priming and straightening
- LP Gases

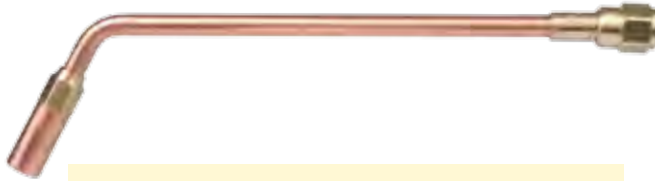

**WARNING: NOT FOR USE WITH ACETYLENE**

Part No.	Type	Size	Tip End Replacement	Length	Series
0323-0303	MFN	12*	-	17.5" (444.5 mm)	HD 310C
0323-0304	MFN	15*	-	17.5" (444.5 mm)	HD 310C
0323-0305	MFN	20*	-	17.5" (444.5 mm)	HD 310C
0323-0292	MFN	8	-	12.0" (304.8 mm)	300
0323-0302	MFN	10	-	17.5" (444.5 mm)	300
0324-0117	MFN-1	6	0311-0611	12.0" (304.8 mm)	100
0324-0118	MFN-1	8	0311-0612	12.0" (304.8 mm)	100

\*Size 12, 15 and 20 MFN heating nozzles must be used with HD 310C torch handle and 3/8" (9.5 mm) hose.

TYPE MFN, MFN-1 – FOR USE WITH PROPANE & NATURAL GAS

Tip Size	Oxygen Pressure (psig)	Fuel Pressure (psig)	Oxygen Consumption (SCFH)	Fuel Consumption (SCFH)	BTU Per Hour
6	8/20	2/10	20/80	5.5/20	
8	10/20	10/15	40/140	10/35	
10	10/30	12/20	80/320	20/80	See Chart
12	30/125	15/25	120/640	30/160	
15	30/125	15/25	200/800	50/200	
20	40/135	15/25	300/1000	75/250	

### BTU PER HOUR

To approximate gross BTU output, multiply flow rate by BTU value listed below:

Propane	2498
Natural Gas	1000
Butane	3374
Propylene	2371

#### WARNING:

- Use flashback arrestors
- Although built to Victor's quality and safety standards, due to the cutting capacity and/or design of each torch, flashback arrestors are not manufactured into the 310C Series Victor heavy industry torches
- To reduce the risk of personal injury, death and/or property damage, use sufficient capacity flashback arrestors with all Victor heavy industry torch products
- Alternative fuel gas only refers to propane, natural gas, propylene gases. Acetylene, hydrogen and gasoline are NOT included as an alternative gas

## MFA/MFA-1 HEATING NOZZLES

For Use with J, 100, 300 & HD310C Series Torch Handles

VICTOR HEAVY INDUSTRY

- Multi-flame heating head for heat treating, straightening and priming
- Acetylene / Hydrogen



Part No. Boxed	Part No. Clamshell	Type	Size	Tip End Replacement	Length	Series
0323-0261	0387-0064	MFA	12	0311-0540	17.5" (444.5 mm)	HD 310C
0323-0262	0387-0065	MFA	15	-	17.5" (444.5 mm)	HD 310C
0323-0250	0387-0060	MFA	4	0311-0536	12.0" (304.8 mm)	300
0323-0251	0387-0061	MFA	6	0311-0537	12.0" (304.8 mm)	300
0323-0252	0387-0062	MFA	8	0311-0538	12.0" (304.8 mm)	300
0323-0260	0387-0063	MFA	10	0311-0539*	12.0" (304.8 mm)	300
0324-0108	-	MFA-1	2	0311-0598	12.0" (304.8 mm)	100
0324-0109	0387-0071	MFA-1	4	0311-0599	12.0" (304.8 mm)	100
0324-0110	0387-0072	MFA-1	6	0311-0600	12.0" (304.8 mm)	100
0324-0111	0387-0073	MFA-1	8	0311-0601	12.0" (304.8 mm)	100
0325-0104	-	MFA-J	2	-	-	J
0325-0105	-	MFA-J	4	-	-	J
0325-0106	0387-0077	MFA-J	6	-	-	J

\*Size 12, 20 and MFA heating nozzles must be used with HD 310C torch handle and 3/8" (9.5 mm) hose.

TYPE MFA, MFA-1 – FOR USE WITH ACETYLENE

Tip Size	Oxygen Pressure (psig)	Acetylene Pressure (psig)	Oxygen Consumption (SCFH)	Acetylene Consumption (SCFH)	BTU Per Hour
2	4/8	4/8	3/10	3/9	
4	8/12	6/10	7/22	6/20	
6	10/15	8/12	15/44	14/40	
8	20/30	10/15	33/88	30/80	See Chart
10	30/40	12/15	44/110	40/100	
12	50/60	12/15	66/165	60/150	
15	50/60	12/15	99/244	90/220	

### BTU PER HOUR

To approximate gross BTU output, multiply flow rate by BTU value listed below:

Acetylene	1470
Methane	1000

#### WARNING:

At no time should the withdrawal rate of an individual acetylene cylinder exceed 1/7 of the cylinder contents per hour. If additional flow capacity is required use an acetylene manifold system of sufficient size to supply the necessary volume.

## SERIES 1 HEATING TIPS



TYPE MFTA – ACETYLENE

For preheating before welding, descaling and paint burning, etc.



Size	Part No.
6	0330-0527
8	0330-0528
*10	0330-0523
*12	0330-0524

\*Use 3/8" (9.5 m) hose and straight torch  
 Required pressures: 12/15 Acetylene; 70/80 psig Oxygen  
 Size 8 is maximum size for use with cutting attachments

## SERIES 1 HEATING TIPS



TYPE MFTN – LP (PROPANE/NATURAL GAS)

For preheating before welding, descaling and paint burning, etc.



Size	Part No.
10	0330-0521
12	0330-0522

Not for use with cutting attachments

## CHT ADAPTOR

(0312-0089)

Concentrated Heating Tip Adaptor for straightening, bending and forming of plate

- For Use with Alternate Fuels
- Use with HPP or HPN size 5 cutting tip, multi-flame elbow, or mixer and nut assembly



NOZZLES

## WELDING NOZZLES

### W Series

FOR USE WITH  
300 SERIES TORCH HANDLES



### W-1 Series

FOR USE WITH  
100 SERIES TORCH HANDLES



### W-J Series

FOR USE WITH  
J SERIES TORCH HANDLES



- General purpose welding & preheating
- Fuel gas usage - acetylene, hydrogen
- 65° tip angle
- Long cone flame
- One piece copper elbow tip

Model	Size	Part No.		Series
		Boxed	Clamshell	
W	000	0323-0110	–	300
	00	0323-0111	0387-0019	300
	0	0323-0112	0387-0020	300
	1	0323-0120	0387-0021	300
	2	0323-0121	0387-0022	300
	3	0323-0122	0387-0023	300
	4	0323-0130	0387-0024	300
	5	0323-0131	–	300
	6	0323-0132	–	300
	7	0323-0140	–	300
W-1	8	0323-0141	–	300
	10	0323-0142	–	300
	000	0324-0068	0387-0028	100
	00	0324-0069	0387-0029	100
	0	0324-0070	0387-0030	100
	1	0324-0071	0387-0031	100
	2	0324-0072	0387-0032	100
	3	0324-0073	0387-0033	100
	4	0324-0074	0387-0034	100
	5	0324-0075	–	100
W-J	6	0324-0076	–	100
	000	0325-0081	–	J
	00	0325-0082	0387-0039	J
	0	0325-0083	0387-0040	J
	1	0325-0084	0387-0041	J
	2	0325-0085	0387-0042	J
	3	0325-0086	0387-0043	J
	5	0325-0088	–	J
6	0325-0089	–	J	
7	0325-0090	–	J	

## ELBOW TIPS

### ET Series

FOR USE WITH  
300 SERIES TORCH HANDLES



### ET-1 Series

FOR USE WITH  
100 SERIES TORCH HANDLES

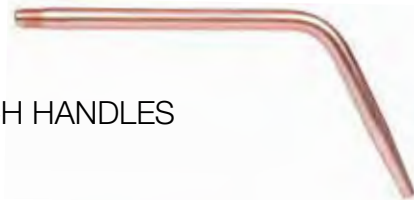

### ET-J Series

FOR USE WITH  
J SERIES TORCH HANDLES

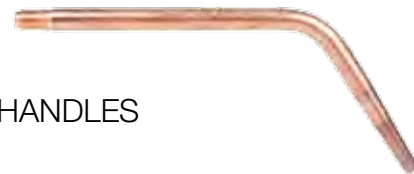

- One piece copper elbow tip
- Long cone flame
- Fuel gas usage - acetylene, hydrogen

Model	Size	Part No.	Series
ET	000	0311-0055	300
	00	0311-0056	300
	0	0311-0057	300
	1	0311-0058	300
	2	0311-0059	300
	3	0311-0572	300
	4	0311-0573	300
	5	0311-0574	300
	6	0311-0575	300
	7	0311-0576	300
ET-1	8	0311-0577	300
	10	0311-0073	300
	3	0311-0345	100
	4	0311-0340	100
ET-J	5	0311-0602	100
	6	0311-0603	100
	000	0311-0123	J
	00	0311-0124	J
	0	0311-0125	J
	1	0311-0126	J
	2	0311-0127	J
	3	0311-0128	J
	4	0311-0129	J

## UM SERIES UNIVERSAL MIXERS

Oxy-Acetylene universal mixers used when exact performance & Individual nozzles are not needed.



Type	Part No.	Fuel Gas Usage	Elbow Tips	Length	Series
4-UM-1	0328-0005	Oxy-Acetylene	000-2 ET, 3 ET-1, 4 ET-1	1.75" (44.5 mm)	100
7-UM-1	0328-0009	Oxy-Acetylene	5 ET-1, 6 ET-1	1.75" (44.5 mm)	100

## RTE SERIES REPLACEABLE Tip Ends

FOR USE WITH 300 SERIES TORCH HANDLES

- General purpose welding & preheating
- Uses replacement tip ends (TE Series)
- 65° tip angle



## RTEN SERIES

- General purpose brazing & preheating
- Long cone flame
- Uses TEN tip ends

Model	Size	Part No.	Fuel Gas Usage	Series
RTE	00	0323-0307	Acetylene, Hydrogen	300
	0	0323-0308	Acetylene, Hydrogen	300
	1	0323-0309	Acetylene, Hydrogen	300
	2	0323-0310	Acetylene, Hydrogen	300
	3	0323-0311	Acetylene, Hydrogen	300
	4	0323-0312	Acetylene, Hydrogen	300
	5	0323-0313	Acetylene, Hydrogen	300
	6	0323-0314	Acetylene, Hydrogen	300
	8	0323-0316	Acetylene, Hydrogen	300
	10	0323-0317	Acetylene, Hydrogen	300
RTEN	6	0323-0284	Natural Gas, Propane	300

## FE SERIES FLEXIBLE ELBOW



- Flexible elbow for special welding, brazing, and heating needs
- Multi-fuel gas service
- Uses replaceable tip ends
- Thread: 5/16"-27

Type	Part No.	Fuel Gas Usage	Tip End Replacements	Length	Series
FE	0323-0191	Multi-Gas Fuel Service	TE, TEN, TEMFA, TEMFN, TEMF	11.5" (292.1 mm)	300
FE-1	0324-0066	Multi-Gas Fuel Service	TE, TEN, TEMFA, TEMFN, TEMF	11.5" (292.1 mm)	100
FE-J	0325-0102	Multi-Gas Fuel Service	TE, TEN, TEMFA, TEMFN, TEMF	11.5" (292.1 mm)	J

## UN SERIES UNIVERSAL NOZZLE



- Standard bend nozzle for welding, brazing and heating
- Uses replaceable tip ends
- 65° tip angle
- Thread: 5/16"-27

Type	Part No.	Fuel Gas Usage	Tip End Replacements	Length	Series
UN	0323-0242	Multi-Gas Fuel Service	TE, TEN, TEMFA, TEMFN, TEMF	5" (127.0 mm)	300
UN-1	0324-0094	Multi-Gas Fuel Service	TE, TEN, TEMFA, TEMFN, TEMF	5" (127.0 mm)	100
UN-J	0325-0101	Multi-Gas Fuel Service	TE, TEN, TEMFA, TEMFN, TEMF	5" (127.0 mm)	J

## DFE SERIES DUAL FLEXIBLE ELBOWS

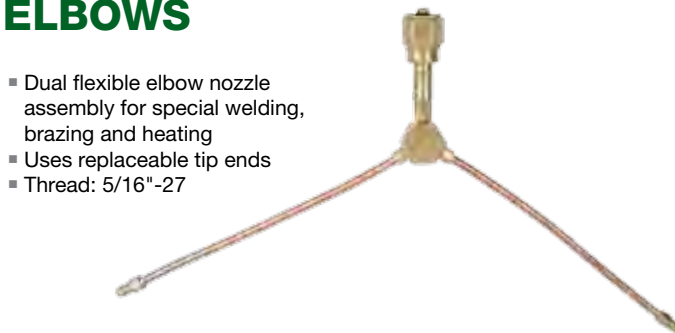

- Dual flexible elbow nozzle assembly for special welding, brazing and heating
- Uses replaceable tip ends
- Thread: 5/16"-27

Type	Part No.	Fuel Gas Usage	Tip End Replacements	Length	Series
DFE	0323-0192	Multi-Gas Fuel Service	TE, TEN, TEMFA, TEMFN, TEMF	-	300
DFE-1	0324-0092	Multi-Gas Fuel Service	TE, TEN, TEMFA, TEMFN, TEMF	-	100
DFE-J	0325-0108	Multi-Gas Fuel Service	TE, TEN, TEMFA, TEMFN, TEMF	-	J

## REPLACEABLE TIP ENDS

TE, TEN, TEMFA, TEMFN & TEMF  
300, 100 & J SERIES

For All Nozzles Using Replaceable Tip Ends			
Type	Application, Description	Fuel Gas	Illustration
TE	Welding, brazing Flame – long Cone One piece	Acetylene	
TEN	Brazing, silver brazing Flame – long Cone One piece	Natural Gas, Propane	
TEMFA	Brazing, silver brazing, heating Flame – multi-flame One piece	Acetylene	
TEMFN	Brazing, silver brazing, heating Flame – multi-flame One piece	All Fuel Gases Except Acetylene	
TEMF	Brazing, soldering, heating Flame – multi-flame Two piece	All Fuel Gases Except Acetylene	

Tip Size, Length, Thread Size				
Type	Size(s)	Length	Thread	Part No.
TE	000	1.5" (38.1 mm)	5/16"-27	0311-0471
	00	1.5" (38.1 mm)	5/16"-27	0311-0472
	0	1.5" (38.1 mm)	5/16"-27	0311-0473
	1	1.5" (38.1 mm)	5/16"-27	0311-0474
	2	1.5" (38.1 mm)	5/16"-27	0311-0475
	3	1.63" (41.4 mm)	5/16"-27	0311-0587
	4	1.88" (47.8 mm)	5/16"-27	0311-0588
	5	2" (50.8 mm)	5/16"-27	0311-0589
	6	2.25" (57.2 mm)	0.393-27	*0311-0590
	8	2.75" (69.9 mm)	0.393-27	*0311-0592
TEN	10	3" (76.2 mm)	0.440-27	*0311-0593
	0	1.5" (38.1 mm)	5/16"-27	0311-0483
	2	1.5" (38.1 mm)	5/16"-27	0311-0485
	3	1.63" (41.4 mm)	5/16"-27	0311-0486
	4	1.88" (47.8 mm)	5/16"-27	0311-0487
	5	2" (50.8 mm)	5/16"-27	0311-0488
	6	2.25" (57.2 mm)	0.393-27	*0311-0585
	1	1.5" (38.1 mm)	5/16"-27	0311-0215
	2	1.5" (38.1 mm)	5/16"-27	0311-0216
	3	1.5" (38.1 mm)	5/16"-27	0311-0217
TEMFA	4	1.5" (38.1 mm)	5/16"-27	0311-0218
	5	1.5" (38.1 mm)	5/16"-27	0311-0219
	3	1.5" (38.1 mm)	5/16"-27	0311-0306
TEMFN	4	1.5" (38.1 mm)	5/16"-27	0311-0307
	5	1.5" (38.1 mm)	5/16"-27	0311-0308
	6	1.5" (38.1 mm)	5/16"-27	0311-0676
TEMF	7	1.5" (38.1 mm)	5/16"-27	0311-0677
	8	1.5" (38.1 mm)	5/16"-27	0311-0678
	9	1.5" (38.1 mm)	5/16"-27	0311-0679
	10	1.5" (38.1 mm)	5/16"-27	0311-0680

Adapter for tip ends to fit tip tube: 5/16"-27(F) x 1/8"-27(M) 0312-0071  
\*Fit nozzles RTE only

## VICTOR "UNIVERSAL TORCHES"

They combine the spiral and injector mixer principles. The result is a high performance torch that operates on any fuel gas.

Universal torch cutting capacity from 1/8" (3.2 mm) to 8" (203.2 mm).

Model ST 2600FC Illustrated  
Patent # 5407348

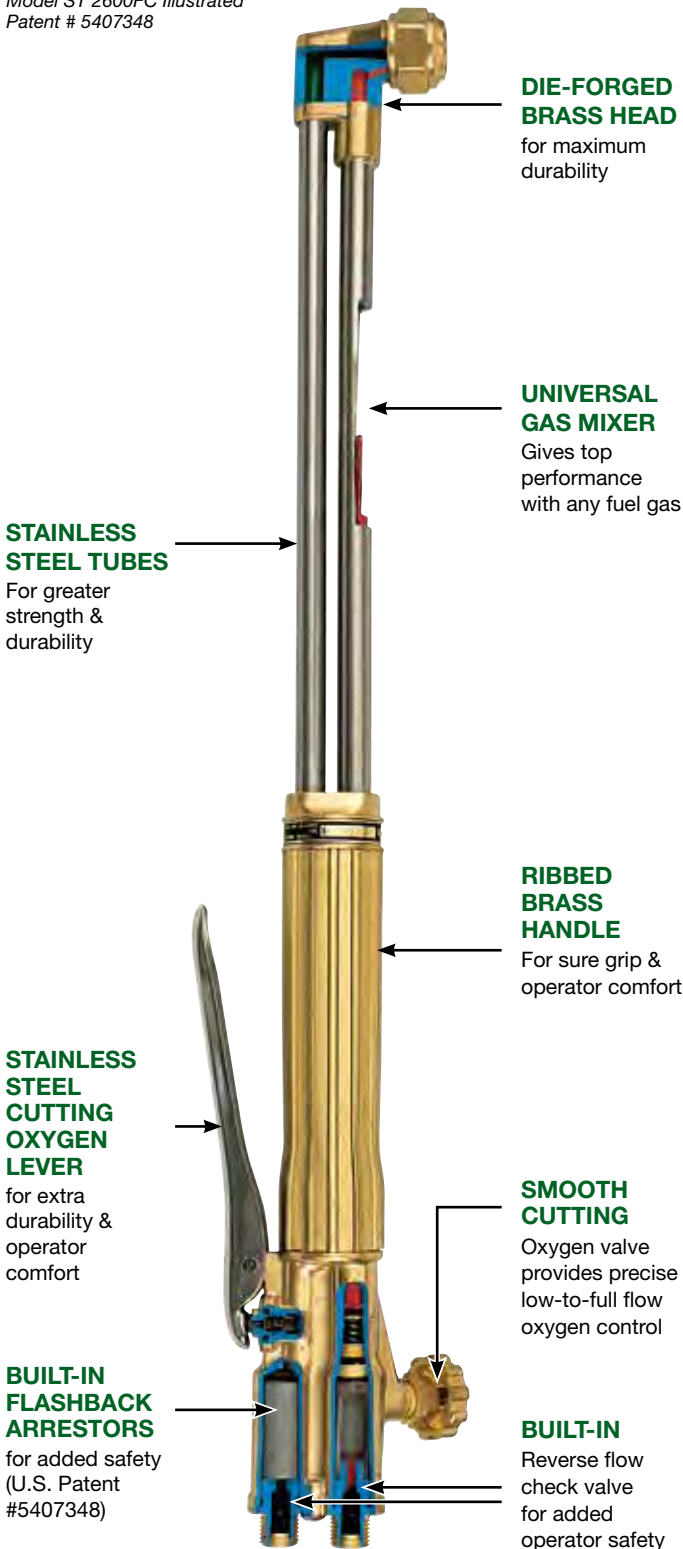

**DIE-FORGED BRASS HEAD**  
for maximum durability

**UNIVERSAL GAS MIXER**  
Gives top performance with any fuel gas

**STAINLESS STEEL TUBES**  
For greater strength & durability

**RIBBED BRASS HANDLE**  
For sure grip & operator comfort

**STAINLESS STEEL CUTTING OXYGEN LEVER**  
for extra durability & operator comfort

**SMOOTH CUTTING**  
Oxygen valve provides precise low-to-full flow oxygen control

**BUILT-IN FLASHBACK ARRESTORS**  
for added safety (U.S. Patent #5407348)

**BUILT-IN**  
Reverse flow check valve for added operator safety

THE HIGH CAPACITY STRAIGHT TORCHES IN THIS SECTION ARE DESIGNED FOR HEAVY CUTTING APPLICATIONS FOUND IN SUCH INDUSTRIES AS SCRAPPING, DEMOLITION AND FOUNDRIES.

### WARNING: USE ADD-ON FLASHBACK ARRESTORS

Although built to Victor's quality and safety standards, due to the cutting capacity and/or design of each torch, flashback arrestors are not manufactured into these Victor Heavy Industry torches.

To reduce the risk of personal injury, death and/or property damage, use sufficient capacity flashback arrestors with all Victor Heavy Industry torch products.

Alternative fuel gas only refers to propane, natural gas, propylene gases. **Acetylene, hydrogen and gasoline** are **NOT** included as an alternative gas.

### DO YOU NEED SPECIAL LENGTH TORCHES?

If you don't see what you need contact  
**Technical Services**

**Call: 800-426-1888 or  
Fax: 800-535-0557**

### Reference Heavy Industry Products

*Victor welcomes your request for special length torches.*

**BUILT-IN REVERSE FLOW CHECK VALVE** for added operator safety

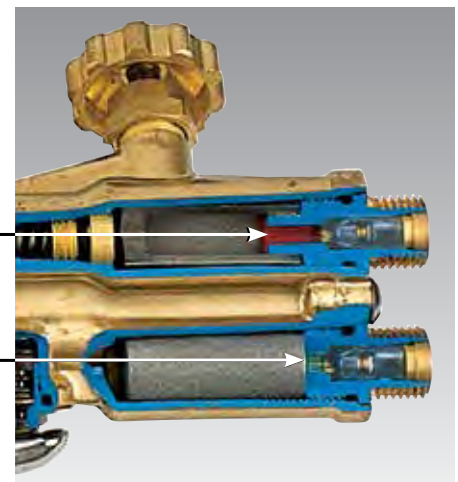

**MOST VICTOR HAND CUTTING TORCHES** are equipped with built-in reverse flow check valves & flash arrestors

## HC 1500C

### VICTOR HEAVY INDUSTRY

#### Three Hose Scrap Straight Cutting Torches

The HC 1500C Series is a three hose design with a 48" cutting capacity and is ideal for heavy steel, scrap cutting. The torch has "C" 7/16"-14 (RH) oxygen connection and standard "B" 9/16"-18 oxygen/fuel preheat connections.

The HC 1500C is manufactured without built-in flashback arrestors. Reverse flow check valves are installed at the inlet connection.

- Three hose connection
- Extra heavy duty
- Cutting capacity 48" (121.9 cm)
- Length: 56" (142.2 cm)
- For use with propane or natural gas
- Not for use with acetylene
- Uses Series 2-285N (two piece) cutting tips
- Special lengths available on request

**WARNING: USE ADD-ON FLASHBACK ARRESTORS.**

**NOT FOR USE WITH ACETYLENE.**

Part No.	Model No.	Head Angle	Hose Connection Preheat	Hose Connection Cutting (Oxygen)	Length	Fuel Gas	Cutting Capacity
0381-0444	HC 1500C	180°	"B" 9/16" -18 LH & RH	"C" 7/8" -14 RH	48" (121.9 cm)	Natural Gas & Propane	48" (121.9 cm)
0381-0509	HC 1500C	90°	"B" 9/16" -18 LH & RH	"C" 7/8" -14 RH	84" (213.4 cm)	Natural Gas & Propane	48" (121.9 cm)
0381-0515	HC 1500C	90°	"B" 9/16" -18 LH & RH	"C" 7/8" -14 RH	96" (243.8 cm)	Natural Gas & Propane	48" (121.9 cm)

Uses Series 2-285N (two piece) cutting tips. See chart below

#### FOR BEST PERFORMANCE, USE THE FOLLOWING RECOMMENDED EQUIPMENT:

##### FLASHBACK ARRESTORS

Gas Service	Part No.	Model	Type
Cutting Oxygen		Not required	
Preheat Oxygen	0657-0076	*FBHC-O	Torch Mount
	0657-0078	FBHC-OR	Regulator Mount

\*Torch mount models also protect the hose

##### REGULATORS

- Cutting Oxygen:
  - ELC4, ESS4-125-540R, ESS7-125-540, SR 700D- 540, or S or L 700D-500/750 line supply
- Preheat Oxygen:
  - ESS4-125-540, SR 450D-540, or S or L 700D-500/750 line supply
- Preheat Fuel:
  - ESS4-125-510LP, SR 461D-510, or S or L 711D-500/750 line supply

##### HOSES

(Contact local distributor for hose information)

- Cutting Oxygen:
  - 1/2" I.D. with "C" hose (7/16"-14 RH) connections
  - Use T-grade or RM-grade hose
- Preheat Oxygen:
  - 3/8" I.D. with "B" hose (9/16"-18 RH) connections
  - Use T-grade hose
- Preheat Fuel:
  - 3/8" I.D. with "B" hose (9/16"-18 LH) connections
  - Use T-grade hose

#### 2-285N TWO PIECE TIPS – FOR USE WITH THE HC 1500C TORCHES

Part No.	Model No.	Size	Cutting Range	Cutting Orifice Dia.	*Cutting Oxygen (psig)	Cutting Oxygen (SCFH)	Preheat Oxygen (psig)	Preheat Oxygen (SCFH)	*Fuel (psig)	Fuel (SCFH)
0336-0041	2-285N	0.25	14" to 20"	0.25	25/45	1500/2400	25/50	250/400	15/20	60/120
0336-0042	2-285N	0.312	20" to 26"	0.312	25/45	2300/3500	25/50	250/400	15/20	60/120
0336-0043	2-285N	0.375	26" to 34"	0.375	20/40	2300/3900	25/50	250/400	15/20	60/120
0336-0044	2-285N	0.437	34" Over	0.437	20/40	2400/4500	25/50	250/400	15/20	60/120

\*Pressure is measured at back of torch when torch is flowing

##### Oxygen Consumption:

1. Adequate volume required. Dual supplies recommended when using cylinders.
2. When operating from bulk oxygen supply it is recommended that separate oxygen drop stations are used.





## HC 1400 Series

VICTOR HEAVY INDUSTRY

Two Hose / High Capacity / Extra Heavy Duty  
Straight Cutting Torch

The HC 1400 Series is a two hose design with a 30" (76.2 cm) cutting capacity. These torches are high capacity, extra heavy duty cutting torches specifically designed for billet cutting or caster cut-off. Other applications include steel mill scrap cutting, foundry work, and riser removal.

The HC 1400 Series is manufactured without built-in flashback arrestors or reverse flow check valves

- Two hose connection
- Extra heavy duty with lock down lever
- Cutting capacity up to 30" (76.2 cm)
- Standard lengths:  
36" (68.6 cm) – 96" (243.8 cm)
- For use with propane or natural gas (not for use with acetylene)
- Uses Series 1, HDNL cutting tips

### INLET CONNECTIONS:

- Oxygen: 7/8"-14 RH "C" Hose  
(with 9/16"-18 RH "B" Hose Adaptor)
- Fuel: 9/16"-18 LH "B" Hose

**WARNING: USE ADD-ON FLASHBACK  
ARRESTORS AND CHECK VALVES.**

**NOT FOR USE WITH ACETYLENE.**

Torch Part No.	Model No.	Head Angle	Length
0381-0771	HC 1411C	75°	27" (68.6 cm)
0381-0774	HC 1431C	75°	36" (91.4 cm)
0381-0773	HC 1430C	90°	36" (91.4 cm)
0381-0775	HC 1432C	180°	36" (91.4 cm)
0381-0776	HC 1450C	90°	48" (121.9 cm)
0381-0777	HC 1451C	75°	48" (121.9 cm)
0381-0778	HC 1452C	180°	48" (121.9 cm)
0381-0782	HC 1460C	90°	60" (152.4 cm)
0381-0783	HC 1461C	75°	60" (152.4 cm)
0381-0784	HC 1462C	180°	60" (152.4 cm)
0381-0779	HC 1470C	90°	72" (182.9 cm)
0381-0780	HC 1471C	75°	72" (182.9 cm)
0381-0781	HC 1472C	180°	72" (182.9 cm)
0381-0785	HC 1490C	90°	96" (243.8 cm)
0381-0787	HC 1492C	180°	96" (243.8 cm)

FOR BEST PERFORMANCE, USE THE FOLLOWING RECOMMENDED EQUIPMENT:

### FLASHBACK ARRESTORS

Gas Service	Part No.	Model	Type
Oxygen	0657-0076	*FBHC-O	Torch Mount
	0657-0078	FBHC-OR	Regulator Mount
Oxygen flashback arrestors not recommended when using tip sizes: 14-16			
Fuel	0657-0011	*FB-F	Torch Mount
	0657-0015	FB-FR	Regulator Mount

\*Torch mount models also protect the hose

### HOSES

(Contact local distributor for hose information)

- Oxygen:
  - 1/2" (12.7 mm) I.D. with "C" hose (7/16"-14 RH) connections.
  - Use T-grade or RM hose
- Fuel:
  - 3/8" (9.5 mm) I.D. with "B" hose (9/16"-18 LH) connections.
  - Use T-grade hose

### REGULATORS

- Oxygen:
  - ELC4, ESS4-125-540R, ESS7-125-540, SR 700D- 540, or S or L 700D-500/750 line supply
- Fuel:
  - ESS4-125-510LP, SR 461D-510, or S or L 711D-500/750 line supply

## ONE PIECE CUTTING TIPS

Part No.	Model No.	Size	Cutting Ranges		Cutting Orifice Dia.		*Oxygen	Oxygen	*Fuel	Fuel
			in	mm	in	mm	(psig/KPA)	(SCFH/LPM)	(psig/KPA)	(SCFH/LPM)
0330-0547	HDNL	10	18	457.2	0.185	4.70	60-100/441-600	750-1650/4354-789	5-15/35-104	90-120/43-57
0330-0548	HDNL	12	22	558.8	0.221	5.61	60-100 /441-690	1000-1950/472-920	5-15/35-104	130-160/61-76
0330-0549	HDNL	14	26	660.4	0.250	6.35	60-100/441-690	1600-2500/755-1180	15-15/35-104	150-190/71-90
0330-0550	HDNL	**16	30	762.0	0.281	7.14	60-100/441-690	1800-3000/850-1418	5-15/35-104	200-240/94-113

\*Flowing pressure at back of torch

\*\*Need 1/2" hose for oxygen



## HC 1200C SERIES

VICTOR HEAVY INDUSTRY  
High Capacity/Heavy Duty

The HC 1200C Series torches are high capacity, heavy duty cutting torches that have a cutting capacity up to 18" (45.7 cm). These torches are used in a wide variety of heavy industrial applications that include scrapping and demolition.

The HC 1200C is manufactured without built-in flashback arrestors. Revers flow check valves are installed at the inlet connection.

- For use with any fuel gas, 2 psig and above
- Universal mixer
- Cutting capacity 18" (45.7 cm)
- Standard Lengths: 21" (53.3 cm) - 96" (243.8 cm)
- Uses Series 1 cutting tips
- "B" 9/16"-18 hose connections
- Extra length models available upon request
- Lock down lever kit available. Part number: 0307-0062

Torch Part No.	Model No.	Head Angle	Length
0381-1402	HC 1200C	90°	21" (53.3 cm)
0381-1403	HC 1201C	75°	21" (53.3 cm)
0381-1404	HC 1202C	180°	21" (53.3 cm)
0381-1405	HC 1230C	90°	36" (91.4 cm)
0381-1406	HC 1231C	75°	36" (91.4 cm)
0381-1407	HC 1232C	180°	36" (91.4 cm)
0381-1408	HC 1250C	90°	48" (121.9 cm)
0381-1432	HC 1250LC*	90°	48" (121.9 cm)
0381-1409	HC 1251C	75°	48" (121.9 cm)
0381-1415	HC 1252C	180°	48" (121.9 cm)
0381-1419	HC 1262C	180°	60" (152.4 cm)
0381-1412	HC 1270C	90°	72" (182.9 cm)
0381-1413	HC 1271C	75°	72" (182.9 cm)
0381-1414	HC 1272C	180°	72" (182.9 cm)
0381-1424	HC 1280C	90°	84" (213.4 cm)
0381-1418	HC 1290C	90°	96" (243.8 cm)

\* Locking Lever

**WARNING: USE ADD-ON FLASHBACK ARRESTORS.**

FOR BEST PERFORMANCE, USE THE FOLLOWING RECOMMENDED EQUIPMENT:

### FLASHBACK ARRESTORS

Gas Service	Part No.	Model	Type	Recommended Tip Size
Oxygen	0657-0010	*FB-O	Torch Mount	Up to size: 8
	0657-0014	FB-OR	Regulator Mount	Up to size: 8
	0657-0076	*FBHC-O	Torch	10 and larger
			Mount/High Flow	10 and larger
Fuel	0657-0011	*FB-F	Torch Mount	-
	0657-0015	FB-FR	Regulator Mount	-
			Mount/High Flow	10 and larger

\* Torch mount models also protect the hose

### HOSES

(Contact local distributor for hose information)

- Oxygen:
  - 3/8" (9.5 mm) I.D. with "B" hose (9/16"-18 LH) connections.
  - Use T-grade hose
- Fuel:
  - 3/8" (9.5 mm) I.D. with "B" hose (9/16"-18 LH) connections.
  - Use T-grade hose

### REGULATORS

- Oxygen:
  - ELC4, ESS4-125-540R, ESS7-125-540, SR 450D- 540 Cylinder, SR 700D-540 cylinder or L 700D/E-500/750 line supply
- Fuel:
  - ESS4-125-510, SR 461D-510 cylinder, SR 711B/C/D-510 or L 711B/C/D-500/750 line supply

# HC 1200C CUTTING TIPS

Part No.	Model No.	Metal Thickness		Cutting Oxygen Pressure		Oxygen		Fuel Pressure		Speed ipm	Kerf Width
		in	mm	psig	SCFH	*psig	SCFH	psig	SCFH		
<b>ACETYLENE (GENERAL PURPOSE TIPS)</b>											
0330-0009	6-1-101	8	203.2	45/55	500/600	-	37/55	7/14	34/50	5/6	0.19
0330-0013	7-1-101	10	254.0	45/55	700/850	-	44/62	10/15	40/56	4/5	0.34
0330-0014	8-1-101	12	304.8	45/55	900/1000	-	53/68	10/15	48/62	3/5	0.41
<b>TIPS FOR DESEAMING, SCARFING, GAUGING, WELD PREPARATION, REMOVING DEFECTIVE WELDS AND WASHING RIVETS</b>											
0330-0114	4-1-118	-	-	40/50	270/320	-	20/33	5/10	18/30	9/12	0.12
0330-0115	6-1-118	-	-	45/55	500/600	-	37/55	7/14	34/50	5/6	0.19
0330-0116	8-1-118	-	-	45/55	900/1000	-	56/68	10/15	48/62	3/5	0.41
<b>MULTI-FLAME HEATING TIPS</b>											
0330-0527	6-MFTA	-	-	-	-	10/15	15/44	8/12	14/40	-	-
0330-0528	8-MFTA	-	-	-	-	20/30	33/88	10/15	30/80	-	-
0330-0523	10-MFTA	-	-	-	-	30/40	44/110	12/15	40/100	-	-
0330-0524	12-MFTA	-	-	-	-	50/60	66/165	12/15	60/150	-	-
<b>NATURAL GAS, PROPANE (GENERAL PURPOSE TIPS)</b>											
0333-0308	6-GPN	8	203.2	55/65	450/500	-	40/220	8/12	20/100	4/6	0.18
0333-0309	7-GPN	10	254.0	55/65	600/700	-	40/220	8/12	20/100	3/5	0.34
0333-0310	8-GPN	12	304.8	60/70	750/850	-	40/220	10/15	20/100	3/4	0.34
<b>TIPS FOR DESEAMING, SCARFING, GOUGING, WELD PREPARATION, REMOVING DEFECTIVE WELDS, WASHING RIVETS</b>											
0330-0178	4-1-128	-	-	45/50	210/250	-	23/108	8/12	16/20	8/11	0.12
0330-0179	6-1-218	-	-	55/65	450/500	-	23/153	10/15	23/35	4/6	0.18
<b>TIPS FOR COARSE SPLINED SCRAP CUTTING - USING NATURAL GAS / PROPANE</b>											
0333-0411	8-CSN	12	304.8	60/70	750/850	-	50/265	10/14	25/120	3/4	0.41
<b>TIPS FOR MILL AND FOUNDRY SCRAP CUTTING UNDER SEVERE CONDITIONS, USE 0309-0025 TIP NUT</b>											
0330-0504	6-HDN	8	203.2	55/65	450/500	-	44/240	8/12	22/110	4/6	0.18
0330-0505	8-HDN	12	304.8	60/70	750/850	-	50/265	10/14	25/120	3/4	0.41
0330-0506	10-HDN	14	355.6	55/65	1000/1200	-	50-265	10/16	25/120	2/4	-
0330-0507	12-HDN	16	406.4	45/55	1150/1350	-	60/290	12/18	30/130	2/3	-
0330-0508	14-HDN	18	457.2	45/55	1300/1500	-	60/290	12/18	30/130	2/3	-
<b>HEAVY PREHEAT TIPS FOR SCRAP, BEVEL &amp; OTHER</b>											
0333-0328	6-HPN	8	203.2	55/65	450/500	-	44/240	8/12	22/110	4/6	0.18
0333-0330	8-HPN	10	254.0	60/70	750/850	-	50/265	10/14	25/120	3/4	0.41
0333-0331	10-HPN	12	304.8	45/55	1000/1200	-	50/265	10/16	25/120	2/4	-
0333-0332	12-HPN	14	355.6	45/55	1150/1350	-	60/290	12/18	30/130	2/3	-
<b>HEAVY WALL SHELL FOR SCRAP, BEVEL &amp; OTHER SEVERE CONDITIONS</b>											
0333-0666	6-HWN	8	203.2	55/65	450/5000	-	44/240	8/12	22/110	4/6	-
0333-0668	8-HWN	10	254.0	60/70	750/850	-	50/265	10/14	25/120	3/4	0.18
0333-0670	10-HWN	12	304.8	45/55	1000/1200	-	50/265	10/16	25/120	2/4	0.41
0333-0671	12-HWN	14	355.6	45/55	1150/1350	-	60/290	12/18	30/130	2/3	-
<b>MULTI-FLAME HEATING TIPS</b>											
0330-0521	10-MFTN	-	-	-	-	10/30	80/320	12/20	20/80	-	-
0330-0522	12/MFTN	-	-	-	-	30/125	120/640	15/25	30/60	-	-

\* Preheat oxygen pressure is controlled by cutting oxygen pressure when using cutting tips



## BULLDOG™ - HC 1100C

### VICTOR HEAVY INDUSTRY Scrap Straight Cutting Torch

With Bulldog torches, superior performance and productivity are assured. The low profile head and lightweight design, strength and durability put Bulldog in a class by itself.

The HC 1100C is manufactured without built-in flashback arrestors. Revers flow check valves are installed at the inlet connection

- Patented head and mixer
- Bottom rear lever with pin/clip design
- Specially designed 'supercharged' preheat oxygen valve
- Reduces flame blow-off
- Bottom located valves for right or left hand use
- Threaded inlet connections with integral check valve for ease of repair
- Body designed for high flow applications
- 3 heavy duty tube supports for ultra strength and durability on extra length models
- UltraMix low-pressure mixer specially designed for LP gas
- Sleek low profile head with no protrusions to hinder cutting
- For use with propane and natural gas

### BULLDOG TIPS BY VICTOR OFFER A COST EFFECTIVE ALTERNATIVE FOR EFFICIENT SCRAP CUTTING

- For scrap cutting
- Heavy wall - two piece design
- Resists slag build-up
- Available in Victor and Harris® styles



**WARNING: USE ADD-ON FLASHBACK ARRESTORS.**

**NOT FOR USE WITH ACETYLENE.**

Part No.	Model No.	Lever Position	Tip Series	Head Angle	Overall Length
<b>VICTOR BULLDOG WITH VICTOR HEAD</b>					
0381-1703	HC 1100C	Bottom Rear	1	90°	21" (53.3 cm)
0381-1704	HC 1101C	Bottom Rear	1	75°	21" (53.3 cm)
0381-1709	HC 1130C	Bottom Rear	1	90°	36" (91.4 cm)
0381-1710	HC 1131C	Bottom Rear	1	75°	36" (91.4 cm)
0381-1711	HC 1132C	Bottom Rear	1	180°	36" (91.4 cm)
0381-1712	HC 1150C	Bottom Rear	1	90°	48" (121.9 cm)
0381-1713	HC 1151C	Bottom Rear	1	75°	48" (121.9 cm)
0381-1714	HC 1152C	Bottom Rear	1	180°	48" (121.9 cm)
0381-1716	HC 1161C	Bottom Rear	1	75°	60" (152.4 cm)
0381-1717	HC 1162C	Bottom Rear	1	180°	60" (152.4 cm)
0381-1718	HC 1170C	Bottom Rear	1	90°	72" (182.9 cm)
0381-1719	HC 1171C	Bottom Rear	1	75°	72" (182.9 cm)
0381-1720	HC 1172C	Bottom Rear	1	180°	72" (182.9 cm)

### VICTOR BULLDOG WITH SEAT DESIGNED FOR HARRIS® STYLE TIP

0381-1698	HC 1100C H1	Bottom Rear	1	90°	21" (53.3 cm)
0381-1721	HC 1131C H1	Bottom Rear	1	75°	36" (91.4 cm)
0381-1722	HC 1151C H1	Bottom Rear	1	75°	48" (121.9 cm)
0381-1745	HC 1171C H1	Bottom Rear	1	75°	72" (182.9 cm)

Harris® is a registered trademark of the Lincoln Electric Company

FOR BEST PERFORMANCE, USE THE FOLLOWING RECOMMENDED EQUIPMENT:

### FLASHBACK ARRESTORS

Gas Service	Part No.	Model	Type	Recommended Tip Size
	0657-0010	*FB-O	Torch Mount	Up to size: 8
	0657-0014	FB-OR	Regulator Mount	Up to size: 8
Oxygen	0657-0076	*FBHC-O	Torch Mount/High Flow	Size: 10 and larger
	0657-0078	FBHC-OR	Regulator Mount/High Flow	Size: 10 and larger
Fuel	0657-0011	*FB-F	Torch Mount	-
	0657-0015	FB-FR	Regulator Mount	-

\*Torch mount models also protect the hose

### HOSES

(Contact local distributor for hose information)

- Oxygen:
  - 3/8" (9.53 mm) I.D. with "B" hose (9/16"-18 LH) connections.
  - Use T-grade hose
- Fuel:
  - 3/8" (9.53 mm) I.D. with "B" hose (9/16"-18 LH) connections.
  - Use T-grade hose

### REGULATORS

- Oxygen:
  - ELC4, ESS4-125-540R, ESS7-125-540, SR 450D-540, SR 700D-540 cylinder, SR 700E-540 cylinder or L 700D/E-500/750 line supply, LC 350DR 540 liquid cylinder
- Fuel:
  - ESS4-125-510LP, SR 461D-510 cylinder, SR 711B/C/D-510, L 711B/C/D-500/750 line supply

# HC 1100C CUTTING TIPS

## TIPS FOR USE WITH NATURAL GAS AND PROPANE CUTTING

Part No.	Model No.	Metal Thickness		Cutting Oxygen Pressure		Preheat Oxygen	Fuel Pressure	
		in	mm	psig	SCFH	SCFH	psig	SCFH
<b>TIPS FOR COARSE SPLINED SCRAP CUTTING – USING NATURAL GAS</b>								
0330-0411	8-CSN	12	304.8	60/70	750/850	50/265	10/14	25/110
<b>TIPS FOR MILL &amp; FOUNDRY SCRAP CUTTING UNDER SEVERE CONDITIONS, USE 0309-0025 TIP NUT</b>								
0330-0504	6-HDN	8	203.2	55/65	450/550	44/240	8/12	22/110
0330-0505	8-DDN	12	304.8	60/70	750/850	50/265	10/14	25/120
0330-0506	10-HDN	14	355.6	55/65	1000/1200	50/265	10/16	25/120
0330-0507	12-HDN	16	406.4	45/55	1150/1350	60/290	12/18	30/130
0330-0508	14-HDN	18	457.2	45/55	1300/1500	60/290	12/18	30/130
<b>HEAVY PREHEAT TIPS FOR SCRAP, BEVEL &amp; OTHER</b>								
0333-0328	6-HPN	8	203.2	55/65	450/500	44/240	8/12	22/110
0333-0330	8-HPN	10	254.0	60/70	750/850	50/265	10/14	25/120
0333-0331	10-HPN	12	304.8	45/55	1000/12000	50/265	10/16	25/120
0333-0332	12-HPN	14	355.6	45/55	1150/1350	60/290	12/18	30/130
<b>HEAVY WALL SHELL FOR SCRAP, BEVEL &amp; OTHER SEVERE CONDITIONS</b>								
0333-0666	6-HWN	8	203.2	55/65	450/500	44/240	8/12	22/110
0333-0668	8-HWN	10	254.0	60/70	750/850	50/265	10/14	25/120
0333-0670	10-HWN	12	304.8	45/55	1000/1200	50/265	10/16	25/120
0333-0671	12-HWN	14	355.6	45/55	1150/1350	60/290	12/18	30/130

Preheat oxygen pressure is controlled by cutting oxygen pressure when using cutting tips

## TIPS FOR USE WITH LP PROPANE AND NATURAL GAS

Part No.	Model No.	Metal Thickness		Cutting Oxygen Pressure		Preheat Oxygen	Fuel Pressure	
		in	mm	psig	SCFH	SCFH	psig	SCFH
<b>VICTOR STYLE TIPS</b>								
6700C0710	VBN-3	2.5	63.5	40/50	150/200	23/140	6/12	12/65
6700C0711	VBN-4	3	76.2	40/50	210/250	23/140	6/12	12/65
6700C0712	VBN-5	5	127.0	45/55	300/360	23/140	6/12	12/65
6700C0713	VBN-6	8	203.2	55/65	450/500	23/140	6/12	12/65
6700C0715	VBN-8	10	254.0	60/70	750/850	44/240	10/18	22/110
6700C0716	VBN-10	12	304.8	45/55	1000/1200	44/240	10/18	22/110
6700C0717	VBN-12	14	355.6	45/55	1150/1350	44/240	10/18	22/110
<b>HARRIS® STYLE TIPS</b>								
6700C0723	HBN-3	3	76.2	40/50	210/250	23/140	6/12	12/65
6700C0724	HBN-4	5	127.0	45/55	300/360	23/140	6/12	12/65
6700C0725	HBN-5	6.5	165.1	55/65	370/440	23/140	6/12	12/65
6700C0726	HBN-6	8	203.2	60/70	450/500	23/140	6/12	12/65

Preheat oxygen pressure is controlled by cutting oxygen pressure when using cutting tips

Harris® is a registered trademark of the Lincoln Electric Company

## ST 2600FC SERIES

### HEAVY DUTY STRAIGHT CUTTING TORCH

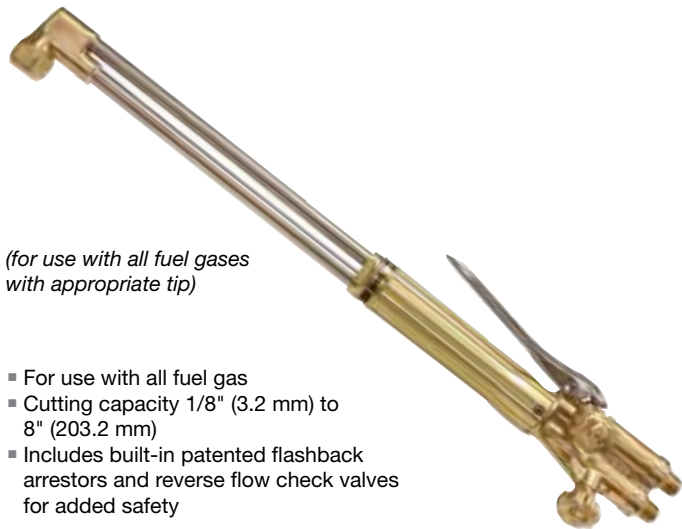

(for use with all fuel gases with appropriate tip)

- For use with all fuel gas
- Cutting capacity 1/8" (3.2 mm) to 8" (203.2 mm)
- Includes built-in patented flashback arrestors and reverse flow check valves for added safety

Part No.	Model No.	Lever Position	Tip Series	Head Angle	Length
0381-1486	SST 2600FC	Top Rear	1	90°	17" (43.2 cm)
0381-1487	SST 2601FC	Top Rear	1	75°	17" (43.2 cm)
0381-1480	ST 2600FC	Top Rear	1	90°	21" (53.3 cm)
0381-1482	ST 2601FC	Top Rear	1	75°	21" (53.3 cm)
0381-1483	ST 2601FCL*	Top Rear	1	75°	21" (53.3 cm)
0381-1484	ST 2602FC	Top Rear	1	180°	21" (53.3 cm)
0381-1490	ST 2610FC	Top Rear	1	90°	27" (68.6 cm)
0381-1491	ST 2611FC	Top Rear	1	75°	27" (68.6 cm)
0381-1492	ST 2612FC	Top Rear	1	180°	27" (68.6 cm)
0381-1496	ST 2630FC	Top Rear	1	90°	36" (91.4 cm)
0381-1498	ST 2631FC	Top Rear	1	75°	36" (91.4 cm)
0381-1500	ST 2632FC	Top Rear	1	180°	36" (91.4 cm)
0381-1502	ST 2650FC	Top Rear	1	90°	48" (121.9 cm)
0381-1503	ST 2651FC	Top Rear	1	75°	48" (121.9 cm)
0381-1514	ST 2651FCL*	Top Rear	1	75°	48" (121.9 cm)
0381-1504	ST 2652FC	Top Rear	1	180°	48" (121.9 cm)
0381-1515	ST 2652FCL*	Top Rear	1	180°	48" (121.9 cm)
0381-1506	ST 2670FC	Top Rear	1	90°	72" (182.9 cm)
0381-1508	ST 2671FC	Top Rear	1	75°	72" (182.9 cm)
0381-1510	ST 2672FC	Top Rear	1	180°	72" (182.9 cm)

\*Locking lever

## ST 1000FC SERIES

### HEAVY DUTY STRAIGHT CUTTING TORCH

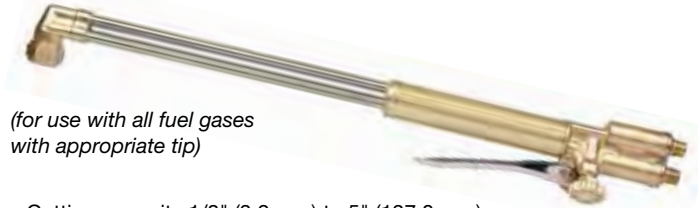

(for use with all fuel gases with appropriate tip)

- Cutting capacity 1/8" (3.2 mm) to 5" (127.0 mm)
- Includes built-in patented flashback arrestors and reverse flow check valves for added safety
- Built-in flashback arrestors no need for accessory flash arrestors
- Built-in reverse flow check valves no need for accessory check valves

Part No.	Model No.	Lever Position	Tip Series	Head Angle	Length
0381-1640	SST 1000FC	Bottom Rear	1	90°	17" (43.2 cm)
0381-1642	SST 1001FC	Bottom Rear	1	75°	17" (43.2 cm)
0381-1641	ST 1000FC	Bottom Rear	1	90°	21" (53.3 cm)
0381-1643	ST 1001FC	Bottom Rear	1	75°	21" (53.3 cm)
0381-1644	ST 1030FC	Bottom Rear	1	90°	36" (91.4 cm)
0381-1645	ST 1031FC	Bottom Rear	1	75°	36" (91.4 cm)
0381-1646	ST 1032FC	Bottom Rear	1	180°	36" (91.4 cm)
0381-1647	ST 1050FC	Bottom Rear	1	90°	48" (121.9 cm)
0381-1648	ST 1051FC	Bottom Rear	1	75°	48" (121.9 cm)
0381-1649	ST 1052FC	Bottom Rear	1	180°	48" (121.9 cm)

## ST 900FC SERIES

### HEAVY DUTY STRAIGHT CUTTING TORCH



(for use with all fuel gases with appropriate tip)

- Cutting capacity: 1/8" (3.2 mm) to 5" (127.0 mm)
- Hose connections are 9/16"-18 unless noted
- Includes built-in patented flashback arrestors and reverse flow check valves for added safety
- Built-in flashback arrestors no need for accessory flash arrestors
- Built-in reverse flow check valves no need for accessory check valves

Part No.	Model No.	Lever Position	Tip Series	Head Angle	Length
0381-1620	SST 900FC	Top Rear	1	90°	17" (43.2 cm)
0381-1622	SST 901FC	Top Rear	1	75°	17" (43.2 cm)
0381-1621	ST 900FC	Top Rear	1	90°	21" (53.3 cm)
0381-1623	ST 901FC	Top Rear	1	75°	21" (53.3 cm)
0381-1628	ST 912FC	Top Rear	1	180°	27" (68.6 cm)
0381-1624	ST 930FC	Top Rear	1	90°	36" (91.4 cm)
0381-1625	ST 931FC	Top Rear	1	75°	36" (91.4 cm)
0381-1626	ST 932FC	Top Rear	1	180°	36" (91.4 cm)
0381-1629	ST 950FC	Top Rear	1	90°	48" (121.9 cm)
0381-1630	ST 951FC	Top Rear	1	75°	48" (121.9 cm)
0381-1631	ST 952FC	Top Rear	1	180°	48" (121.9 cm)
0381-1654	ST 972FC	Top Rear	1	180°	72" (182.9 cm)
0381-1685	ST 991FC	Top Rear	1	75°	96" (243.8 cm)

## ST 400C SERIES

HEAVY DUTY



*(for use with all fuel gases with appropriate tip)*

- For use with all fuel gas, 5 psig and above
- Cutting capacity up to 6" (300.0 mm)
- Hose connections are 9/16"-18 unless noted
- Built-in reverse flow check valves no need for accessory check valves

### SPECIAL DESIGNED ALLOY MATERIAL:

- 3x the tensile strength of Brass
- Ergonomic, textured, precision contoured handle is designed to reduce operator fatigue and provide better grip
- Durable to withstand tough use and prevention of dents and scratches

### INTUITIVE KNOBS:

- Color coded
- Clearly marked lettering with increase/decrease label
- Understandable in any language

Part No.	Model No.	Lever Position	Tip Series	Head Angle	Length
0381-1987	ST 400C	Top Rear	1	90°	21" (53.3 cm)

## ST 300FC SERIES

HEAVY DUTY



*(for use with all fuel gases with appropriate tip)*

- For use with all fuel gas, 5 psig and above
- Cutting capacity: 1/8" (3.2 mm) to 5" (127.0 mm)
- Hose connections are 9/16"-18 unless noted
- Includes built-in patented flashback arrestors and reverse flow check valves for added safety
- Built-in flashback arrestors no need for accessory flash arrestors
- Built-in reverse flow check valves no need for accessory check valves

Part No.	Model No.	Lever Position	Tip Series	Head Angle	Length
0381-1917	ST 300FC	Top Rear	1	90°	21" (53.3 cm)



## SAFETY ACCESSORIES

### FLASHBACK ARRESTORS AND CHECK VALVES

Flashback arrestors and reverse flow check valves provide additional protection against flashbacks. Victor recommends the use of these devices whenever possible. Victor add-on flashback arrestors contain both a reverse flow check valve and a flashback arrestor.

Due to the high flow requirements of Victor Heavy Industry torches, it is important to use flashback arrestors that have sufficient flow capacity.

**IT IS IMPORTANT TO UNDERSTAND THE DIFFERENCE BETWEEN REVERSE FLOW CHECK VALVES AND FLASHBACK ARRESTORS.**

#### REVERSE FLOW CHECK VALVES:

Helps to prevent the reverse flow of gases from traveling past the check valve.

#### FLASHBACK ARRESTORS:

Prevents a flame from traveling past the flashback arrestor in the event of a flashback.

**NOTE:** The use of both regulator and torch mount flashback arrestors with heavy industry equipment requiring high gas volume is not recommended because it may cause excessive flow restriction. It is always better to place the safety devices at the rear of the torch than at the regulator in order to protect the hose.

### THE FLASHBACK ARRESTOR

PREVENTS FLASHBACK

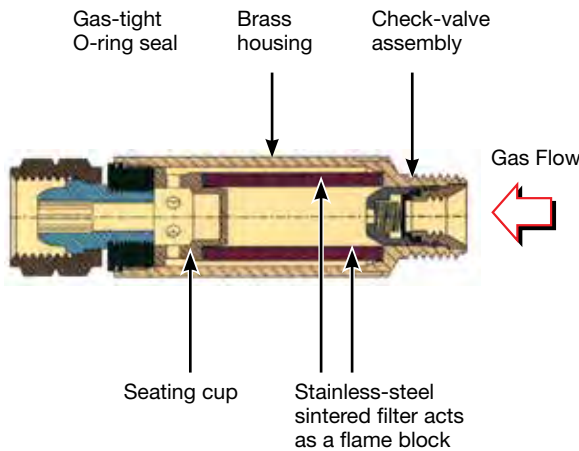

### THE CHECK VALVE

PREVENTS THE REVERSE FLOW OF GASES

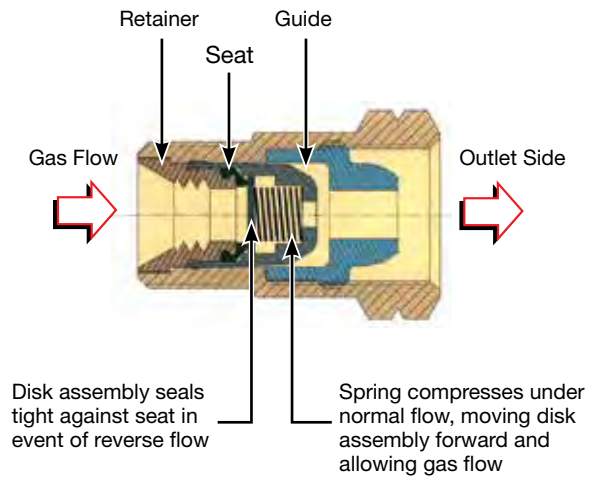

### CONVERSION CHART

Gas	Conversion Factor	Max. Pressure
Acetylene	1.05	15 psi
Hydrogen	3.79	30 psi
Mapp	0.82	22 psi
Methane	1.34	50 psi
Oxygen	0.95	143 psi
Propane	0.80	50 psi



# FLAMEBUSTER™ HIGH FLOW

FBHC-O

High Flow Torch Mount



FBHC-OR

High Flow Regulator Mount



FBHC-OC

High Flow Torch Mount



FBHC-ORC

High Flow Regulator Mount



## FLOW CHART - FBHC SERIES FLASHBACK ARRESTOR

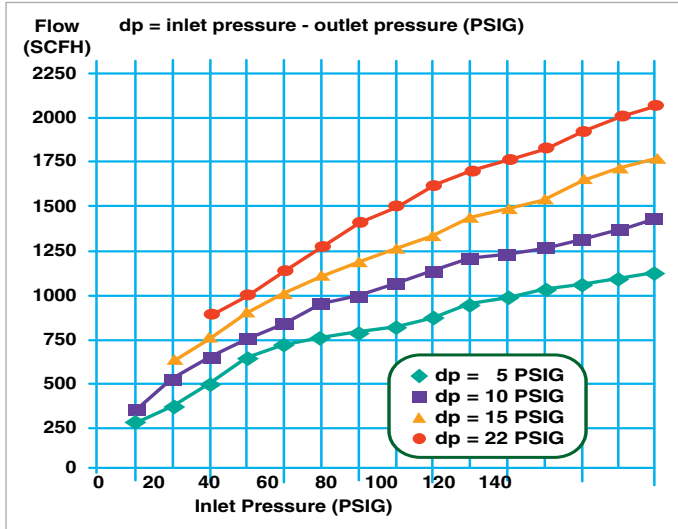

Part No.	Model No.	Gas	Description	Connection
<b>OXYGEN - TORCH MOUNT</b> (Torch mount models also protect hose)				
0657-0076	FBHC-O	Oxygen	Torch Mount - High Flow	"B" 9/16"-18 RH (CGA 022)
0657-0077	FBHC-OC	Oxygen	Torch Mount - High Flow	"C" 7/8" - 14 RH (CGA 024)
<b>OXYGEN - REGULATOR MOUNT</b>				
0657-0078	FBHC-OR	Oxygen	Regulator Mount - High Flow	"B" 9/16" - 18 RH (CGA 022)
0657-0079	FBHC-ORC	Oxygen	Regulator Mount - High Flow	"C" 7/8" - 14 RH (CGA 024)

Flow rates shown in chart are for air. To convert to other gases, multiply the air flow rate by the conversion factor listed.  
Nothing can take the place of proper equipment operation. Always read, understand and follow the instructions provided with each product.

# FLAMEBUSTER™

FB-O

Torch Mount - Oxygen



FB-OR

Regulator Mount - Oxygen



FB-F

Torch Mount - Fuel



FB-FR

Regulator Mount - Fuel



## FLOW CHART - FB SERIES FLASHBACK ARRESTOR

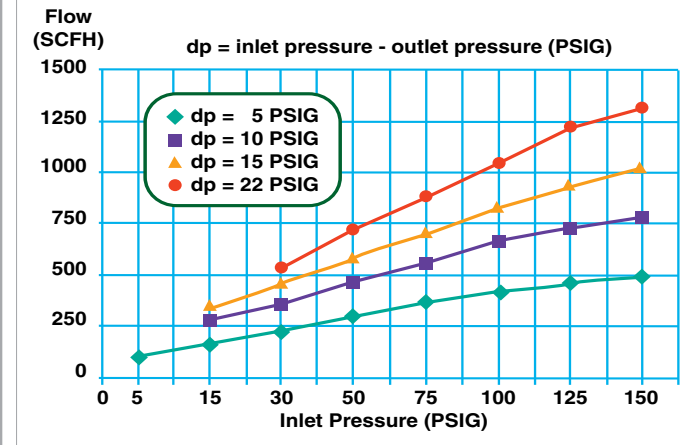

Part No.	Model No.	Gas	Description	Connection
<b>OXYGEN - TORCH MOUNT</b>				
0657-0010	FB-O	Oxygen	Torch Mount	"B" 9/16"-18 RH (CGA 022)
<b>OXYGEN - REGULATOR MOUNT</b>				
0657-0014	FB-OR	Oxygen	Regulator Mount	"B" 9/16"-18 RH (CGA 022)
<b>FUEL - TORCH MOUNT</b>				
0657-0011	FB-F	Fuel	Torch Mount	"B" 9/16"-18 LH (CGA 023)
<b>FUEL - REGULATOR MOUNT</b>				
0657-0015	FB-FR	Fuel	Regulator Mount	"B" 9/16"-18 LH (CGA 023)
<b>PAIR PACKS</b>				
0656-0001	FB-1	Oxy/Fuel	Torch Mount	"B" 9/16"-18 RH/LH (CGA 022 & 023)
0656-0004	FBR-1	Oxy/Fuel	Regulator	"B" 9/16"-18 RH/LH (CGA 022 & 023)

Flow rates shown in chart are for air. To convert to other gases, multiply the air flow rate by the conversion factor listed.  
Nothing can take the place of proper equipment operation. Always read, understand and follow the instructions provided with each product.

SAFETY

**VICTOR® ADD-ON FLASHBACK ARRESTORS CONTAIN BOTH A REVERSE FLOW CHECK VALVE AND A FLASHBACK ARRESTOR**

## FLAMEBUSTER™ PLUS

FLASHBACK ARRESTOR WITH  
KWIK-CONNECT™ COUPLING

Designed to prevent flashback from torch to hose (Not for regulators)



Part No.	Model	Description
0656-0002	FBP-1	FlameBuster Plus Torch - Pair Pack
0657-0002	FBP-0	FlameBuster Plus Torch
0657-0003	FBP-F	FlameBuster Plus Torch

Plug Assemblies available: Oxygen: 0657-0031, Fuel: 0657-0032

FLASHBACK ARRESTOR WITH KWIK-CONNECT  
COUPLING COMPONENTS FBP-1

Part No.	Gas	Description
0657-0031	Oxygen	Male End
0657-0032	Fuel Gas	Male End

## FLASHBACK ARRESTORS

PAIR PACKS



Part No.	Model No.	Gas	Description	Connection
0656-0006	FBT-2	Oxy/Fuel	Torch Mount	"B" 9/16"-18 RH/LH (CGA 022 & 023)
0656-0007	FBR-2	Oxy/Fuel	Regulator Mount	"B" 9/16"-18 RH/LH (CGA 022 & 023)

## REVERSE FLOW CHECK VALVES

FOR TORCHES & REGULATORS



Part No.	Description
----------	-------------

### TORCH MODELS

0690-0011	CTO & CTF Torch - Check Valves Pair Pack (Oxygen & Fuel)
0690-0032	CTO Torch - Check Valve (Oxygen)
0690-0033	CTF Torch - Check Valve (Fuel)

### REGULATOR MODELS

0690-0012	CRO & CRF Regulator - Check Valves Pair Pack (Oxygen & Fuel)
0690-0034	CRO Regulator - Check Valve (Oxygen)
0690-0035	CRF Regulator - Check Valve (Fuel)

## BUILT-IN FLASH ARRESTOR

RETRO-FIT KIT

The retro-fit kit allows replacement of built-in flash arrestors for cutting torches without the use of Loctite® or heat

Part No.	Description
<b>TORCH/HOSE CONNECTIONS</b>	
0656-0046	Includes oxygen and fuel cartridges, retainer plate and screws, hex key, and instructions

Repair of oxy/fuel equipment, including flashback arrestor and check valve replacement, should be done by a qualified technician.

## VANGUARD™ FLASHBACK ARRESTOR

REPLACEMENT CARTRIDGE



Part No.	Description
<b>TORCH/HOSE CONNECTIONS</b>	
0657-0036	Torch and Torch Handle Replacement Cartridge (315FC, 100FC, J 100FC) (CST 800FC) (Both Gases)
0657-0068	Torch & Torch Handle Replacement Cartridge (H 315FC, ST 900FC, ST 1000FC, ST 2600FC) (Oxygen)
0657-0069	Torch & Torch Handle Replacement Cartridge (H 315FC, ST 900FC, ST 1000FC, ST 2600) (Fuel Gas)

Flashback arrestor replacement cartridges include an "O" ring but does not include a replacement reverse flow check valve. Part No. 0690-0027 - 9/16" (pair)

## KWIK-CONNECT

TORCH/HOSE CONNECTIONS



Part No.	Description
<b>TORCH/HOSE CONNECTIONS</b>	
0656-0000	KC-1 Kwik Connect Pair Pack (Oxygen and Fuel)
0312-0090	KCO Kwik Connect (Oxygen)
0312-0091	KCF Kwik Connect (Fuel)

## SELECTION & REFERENCE INFORMATION

### CUTTING ORIFICE REFERENCE CHART - CUTTING TIP SIZE

For all standard cutting tips except Series MTH high speed models												
000	00	0	1	2	3	4	5	6	7	8	10	12
•	•	•	•	•	•	•	•	•	•	•	•	•
0.027	0.033	0.041	0.047	0.060	0.071	0.083	0.100	0.121	0.141	0.162	0.185	0.221

**Orifice Diameter - inches** (Orifice diameters shown actual size)

### CODE FOR FUEL GASES

<b>A</b>	<b>Acetylene</b>
<b>LP</b>	<b>Propane/Natural Gas</b>
<b>P</b>	<b>Propylene</b>

### PREHEAT CHART FOR PROPYLENE & LP TIPS

Torch Series	Preheat Oxygen (psig)	Preheat Fuel (psig)
MT 200	--	8 oz and up
MT 300	30/35	8 oz and up
ST 2600FC	--	1 psig and up
ST 900FC	--	5 psig and up
ST 1000FC	--	5 psig and up

### CUTTING TORCHES

Handle	Cutting Attachment	Fuel Gas
CUTTING TORCHES		
315FC, H 315FC	CA 2460-90°	All
315FC, H 315FC	CA 2461-75°	All
315FC, H 315FC	CA 2462-180°	All
STRAIGHT TORCHES		
ST 2600FC	-	All
ST 1000FC	-	All
ST 900FC	-	All
*HC 1200C	-	All
MACHINE TORCHES		
MT 200	-	A, LP
MT 300	-	A, LP

### MATERIAL THICKNESS - TIP SIZE

Material Thickness		Tip Size
Inches	mm	
1/8"	3.2 mm	000
1/4"	6.4 mm	00
3/8" - 1/2"	9.5 - 12.7 mm	0
3/4"	19.1 mm	1
1" - 1 1/2"	25.4 - 38.1 mm	2
2" - 2 1/2"	50.8 - 63.5 mm	3
3"	76.2 mm	4
4" - 5"	102 - 127 mm	5
6" - 8"	152 - 203 mm	6*
10"	254 mm	7*
12"	305 mm	8*

*\*For best results, use "High Flow Handles" and 3/8" hose*

### GOUGING DEPTH TIP CHART

Approximate Gouge Depth				
Depth of gouge will vary due to angle of tip and cutting pressure.				
Type	Tip Size	Depth of Gouge	O <sub>2</sub> psi	C <sub>2</sub> H <sub>2</sub> psi
118	0	1/8"-1/4"	30-45	5-7
	2	1/4"-3/8"	30-45	5-7
	8	1/4"-1/2"	30-55	6-8
218	4	1/4"-3/4"	30-65	8-10
	6	3/8"-1"	30-65	10-12

**CUTTING TIPS**

## TIP NUT

**0309-0018**

*For Series 1 cutting tips*









**0309-0003**

*For Series 3 cutting tips*

## SERIES 1 – ACETYLENE CUTTING TIPS

### ACETYLENE

Series 1 tip style, fuel gas usage and Victor equipment compatibility shown below

Type		Fuel Gas	Application
101		A	<ul style="list-style-type: none"> <li>General purpose</li> <li>Hand and machine torch cutting</li> </ul>
101 <sup>30°</sup>		A	<ul style="list-style-type: none"> <li>General purpose</li> <li>Hand and machine torch cutting 30°, with torch perpendicular</li> </ul>
101-L		A	<ul style="list-style-type: none"> <li>General purpose, extra length tips</li> </ul>
108		A	<ul style="list-style-type: none"> <li>Boiler tube removal</li> <li>Tips are short to insert head and tip inside tube</li> </ul>
112		A	<ul style="list-style-type: none"> <li>Cutting close to bulk heads</li> <li>Hand cutting of rivet heads</li> </ul>
118 Tip (Round)		A	<ul style="list-style-type: none"> <li>Deseaming, scarfing, gouging, weld preparation, removing defective welds, washing rivets</li> </ul>
118 Tip (Sides Cutaway)		A	<ul style="list-style-type: none"> <li>Deseaming, scarfing, gouging, weld preparation, removing defective welds, washing rivets</li> </ul>

Tip packaging is color coded with reference to fuel gas usage. Other special application tips available. Contact Technical Services at 1-800-426-1888

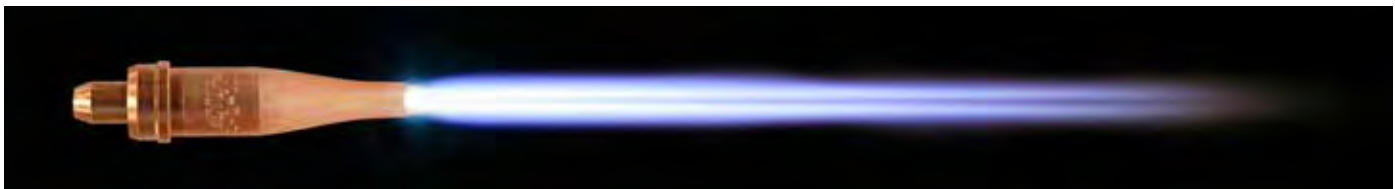

Data compiled using mild steel as test material.

\* Applicable for three hose machine torch only. With a two hose cutting torch, preheat pressure is set by the cutting oxygen.

\*\* For best results use ST2600FC series torches and 3/8" hose when using tip size 6 or larger.

\*\*\* All pressures are measured at the regulator using 25' x 1/4" hose through tip size 5 and 25' x 3/8" hose for tip size 6 and larger.

\*\*\*\* Oxygen consumption is 1.1 times the acetylene under neutral flame conditions.

**WARNING:** At no time should the withdrawal rate of an individual acetylene cylinder exceed 1/7 of the cylinder contents per hour. If additional flow capacity is required use an acetylene manifold system of sufficient size to supply the necessary volume.

## VICTOR SERIES 1 TYPE 101



- General purpose
- Hand and machine torch cutting

Metal Thickness (Inches)	Size	Part No.	Cutting Oxygen ***(psig)	Cutting Oxygen (SCFH)	Preheat Oxygen *(psig)	Preheat Oxygen (SCFH)	Acetylene (psig)	Acetylene ****(SCFH)	Speed ipm	Kerf Width
1/8"	000	0330-0003	20 / 25	20 / 25	3 / 5	3 / 5	3 / 5	3 / 5	28 / 32	.04
1/4"	00	0330-0004	20 / 25	30 / 35	3 / 5	4 / 6	3 / 5	4 / 6	27 / 30	.05
1/4"	00	0387-0133#	20 / 25	30 / 35	3 / 5	4 / 6	3 / 5	4 / 6	27 / 30	.05
3/8"	0	0330-0012	25 / 30	55 / 60	3 / 5	5 / 9	3 / 5	5 / 8	24 / 28	.06
3/8"	0	0387-0134#	25 / 30	55 / 60	3 / 5	5 / 9	3 / 5	5 / 8	24 / 28	.06
1/2"	0	0330-0012	30 / 35	60 / 65	3 / 6	7 / 11	3 / 5	6 / 10	20 / 24	.06
1/2"	0	0387-0134#	30 / 35	60 / 65	3 / 6	7 / 11	3 / 5	6 / 10	20 / 24	.06
3/4"	1	0330-0005	30 / 35	80 / 85	4 / 7	9 / 14	3 / 5	8 / 13	17 / 21	.07
3/4"	1	0387-0135#	30 / 35	80 / 85	4 / 7	9 / 14	3 / 5	8 / 13	17 / 21	.07
1"	2	0330-0006	40 / 45	150 / 160	4 / 12	13 / 20	3 / 7	12 / 18	13 / 17	.09
1"	2	0387-0136#	40 / 45	150 / 160	4 / 12	13 / 20	3 / 7	12 / 18	13 / 17	.09
1 1/2"	2	0330-0006	40 / 45	150 / 160	4 / 12	13 / 20	3 / 7	12 / 18	13 / 17	.09
1 1/2"	2	0387-0136#	40 / 45	150 / 160	4 / 12	13 / 20	3 / 7	12 / 18	13 / 17	.09
2"	3	0330-0002	40 / 45	210 / 225	5 / 14	15 / 24	4 / 9	14 / 22	12 / 15	.11
2 1/2"	3	0330-0002	45 / 50	225 / 240	5 / 16	18 / 29	4 / 10	16 / 26	10 / 13	.11
3"	4	0330-0007	40 / 50	270 / 320	6 / 17	20 / 33	5 / 10	18 / 30	9 / 12	.12
4"	5	0330-0008	45 / 55	390 / 425	7 / 18	24 / 37	5 / 12	22 / 34	8 / 11	.15
5"	5	0330-0008	50 / 55	425 / 450	7 / 20	29 / 41	5 / 13	26 / 38	7 / 9	.15
6"	6**	0330-0009	45 / 40	500 / 600	10 / 22	33 / 48	7 / 13	30 / 44	6 / 8	.18
8"	6**	0330-0009	45 / 55	500 / 600	10 / 25	37 / 55	7 / 14	34 / 50	5 / 6	.19
10"	7**	0330-0013	45 / 55	700 / 850	15 / 30	44 / 62	10 / 15	40 / 56	4 / 5	.34
12"	8**	0330-0014	45 / 55	900 / 1000	20 / 35	53 / 68	10 / 15	48 / 62	3 / 5	.41

## G-SERIES SERIES 1 TYPE 101

Metal Thickness (Inches)	Size	Part no.	Model no.	Cutting Oxygen ***(psig)	Cutting Oxygen (SCFH)	Preheat Oxygen *(psig)	Preheat Oxygen (SCFH)	Acetylene (psig)	Acetylene ****(SCFH)	Speed ipm	Kerf Width
1/8"	000	6700C2408	CS1101000	20 / 25	20 / 25	3 / 5	3 / 5	3 / 5	3 / 5	28 / 32	.04
1/4"	00	6700C2409	CS110100	20 / 25	30 / 35	3 / 5	4 / 6	3 / 5	4 / 6	27 / 30	.05
3/8"	0	6700C2410	CS11010	25 / 30	55 / 60	3 / 5	5 / 9	3 / 5	5 / 8	24 / 28	.06
1/2"	0	6700C2410	CS11010	30 / 35	60 / 65	3 / 6	7 / 11	3 / 5	6 / 10	20 / 24	.06
3/4"	1	6700C2411	CS11011	30 / 35	80 / 85	4 / 7	9 / 14	3 / 5	8 / 13	17 / 21	.07
1"	2	6700C2412	CS11012	35 / 40	140 / 150	4 / 9	11 / 18	3 / 6	10 / 16	15 / 19	.09
1 1/2"	2	6700C2412	CS11012	40 / 45	150 / 160	4 / 12	13 / 20	3 / 7	12 / 18	13 / 17	.09
2"	3	6700C2413	CS11013	40 / 45	210 / 225	5 / 14	15 / 24	4 / 9	14 / 22	12 / 15	.11
2 1/2"	3	6700C2413	CS11013	45 / 50	225 / 240	5 / 16	18 / 29	4 / 10	16 / 26	10 / 13	.11
3"	4	6700C2414	CS11014	40 / 50	270 / 320	6 / 17	20 / 33	5 / 10	18 / 30	9 / 12	.12
4"	5	6700C2415	CS11015	45 / 55	390 / 425	7 / 18	24 / 37	5 / 12	22 / 34	8 / 11	.15
5"	5	6700C2415	CS11015	50 / 55	425 / 450	7 / 20	29 / 41	5 / 13	26 / 38	7 / 9	.15
6"	6**	6700C2416	CS11016	45 / 40	500 / 600	10 / 22	33 / 48	7 / 13	30 / 44	6 / 8	.18
8"	6**	6700C2416	CS11016	45 / 55	500 / 600	10 / 25	37 / 55	7 / 14	34 / 50	5 / 6	.19
10"	7**	6700C2417	CS11017	45 / 55	700 / 850	15 / 30	44 / 62	10 / 15	40 / 56	4 / 5	.34
12"	8**	6700C2418	CS11018	45 / 55	900 / 1000	20 / 35	53 / 68	10 / 15	48 / 62	3 / 5	.41

CUTTING TIPS

Data compiled using mild steel as test material.

\* Applicable for three hose machine torch only. With a two hose cutting torch, preheat pressure is set by the cutting oxygen.

\*\* For best results use ST2600FC series torches and 3/8" hose when using tip size 6 or larger.

\*\*\* All pressures are measured at the regulator using 25' x 1/4" hose through tip size 5 and 25' x 3/8" hose for tip size 6 and larger.

\*\*\*\* Oxygen consumption is 1.1 times the acetylene under neutral flame conditions.

# Clam Shell Packaging

**WARNING:** At no time should the withdrawal rate of an individual acetylene cylinder exceed 1/7 of the cylinder contents per hour. If additional flow capacity is required use an acetylene manifold system of sufficient size to supply the necessary volume.

## VICTOR SERIES 1 TYPE 101 30°



- General purpose
- Hand and machine torch cutting 30°, with torch perpendicular

Metal Thickness (Inches)	Size	Part No.	Cutting Oxygen ***(psig)	Cutting Oxygen (SCFH)	Preheat Oxygen *(psig)	Preheat Oxygen (SCFH)	Acetylene (psig)	Acetylene ****(SCFH)	Speed ipm	Kerf Width
3/8"	0	0330-0198	25 / 30	55 / 60	3 / 5	5 / 9	3 / 5	5 / 8	24 / 28	.06
1/2"	0	0330-0198	30 / 35	60 / 65	3 / 6	7 / 11	3 / 5	6 / 10	20 / 24	.06
3/4"	1	0330-0199	30 / 35	80 / 85	4 / 7	9 / 14	3 / 5	8 / 13	17 / 21	.07
1"	2	0330-0284	35 / 40	140 / 150	4 / 9	11 / 18	3 / 6	10 / 16	15 / 19	.09

## VICTOR SERIES 1 TYPE 101-L

- General purpose
- Extra length tips



Metal Thickness (Inches)	Size	Part No.	Cutting Oxygen *** (psig)	Cutting Oxygen (SCFH)	Preheat Oxygen *(psig)	Preheat Oxygen (SCFH)	Acetylene (psig)	Acetylene **** (SCFH)	Speed ipm	Kerf Width
3"	4	0330-0531	40 / 50	270 / 320	6 / 17	20 / 33	5 / 10	18 / 30	9 / 12	.12
6"	6**	0330-0535	45 / 40	500 / 600	10 / 22	33 / 48	7 / 13	30 / 44	6 / 8	.18

## VICTOR SERIES 1 TYPE 108



- Boiler tube removal
- Tip is short to insert head and tip inside tube

Metal Thickness (Inches)	Size	Part No.	Cutting Oxygen *** (psig)	Cutting Oxygen (SCFH)	Preheat Oxygen *(psig)	Preheat Oxygen (SCFH)	Acetylene (psig)	Acetylene **** (SCFH)	Speed ipm	Kerf Width
3/8"	0	0330-0058	25 / 30	55 / 60	3 / 5	5 / 9	3 / 5	5 / 8	24 / 28	.06
1/2"	0	0330-0058	30 / 35	60 / 65	3 / 6	7 / 11	3 / 5	6 / 10	20 / 24	.06
3/4"	1	0330-0059	30 / 35	80 / 85	4 / 7	9 / 14	3 / 5	8 / 13	17 / 21	.07
1"	2	0330-0063	35 / 40	140 / 150	4 / 9	11 / 18	3 / 6	10 / 16	15 / 19	.09
1 1/2"	2	0330-0063	40 / 45	150 / 160	4 / 12	13 / 20	3 / 7	12 / 18	13 / 17	.09
2"	3	0330-0064	40 / 45	210 / 225	5 / 14	15 / 24	4 / 9	14 / 22	12 / 15	.11
2 1/2"	3	0330-0064	45 / 50	225 / 240	5 / 16	18 / 29	4 / 10	16 / 26	10 / 13	.11
3"	4	0330-0065	40 / 50	270 / 320	6 / 17	20 / 33	5 / 10	18 / 30	9 / 12	.12

## G-SERIES SERIES 1 TYPE 108

Metal Thickness (Inches)	Size	Part no.	Model no.	Cutting Oxygen *** (psig)	Cutting Oxygen (SCFH)	Preheat Oxygen *(psig)	Preheat Oxygen (SCFH)	Acetylene (psig)	Acetylene **** (SCFH)	Speed ipm	Kerf Width
3/8"	0	6700C2990	CS11080	25 / 30	55 / 60	3 / 5	5 / 9	3 / 5	5 / 8	24 / 28	.06
1/2"	0	6700C2990	CS11080	30 / 35	60 / 65	3 / 6	7 / 11	3 / 5	6 / 10	20 / 24	.06
3/4"	1	6700C2991	CS11081	30 / 35	80 / 85	4 / 7	9 / 14	3 / 5	8 / 13	17 / 21	.07
1"	2	6700C2992	CS11082	35 / 40	140 / 150	4 / 9	11 / 18	3 / 6	10 / 16	15 / 19	.09
1 1/2"	2	6700C2992	CS11082	40 / 45	150 / 160	4 / 12	13 / 20	3 / 7	12 / 18	13 / 17	.09
2"	3	6700C2993	CS11083	40 / 45	210 / 225	5 / 14	15 / 24	4 / 9	14 / 22	12 / 15	.11
2 1/2"	3	6700C2993	CS11083	45 / 50	225 / 240	5 / 16	18 / 29	4 / 10	16 / 26	10 / 13	.11
3"	4	6700C2994	CS11084	40 / 50	270 / 320	6 / 17	20 / 33	5 / 10	18 / 30	9 / 12	.12

Data compiled using mild steel as test material.

\* Applicable for three hose machine torch only. With a two hose cutting torch, preheat pressure is set by the cutting oxygen.

\*\* For best results use ST2600FC series torches and 3/8" hose when using tip size 6 or larger.

\*\*\* All pressures are measured at the regulator using 25' x 1/4" hose through tip size 5 and 25' x 3/8" hose for tip size 6 and larger.

\*\*\*\* Oxygen consumption is 1.1 times the acetylene under neutral flame conditions.

**WARNING:** At no time should the withdrawal rate of an individual acetylene cylinder exceed 1/7 of the cylinder contents per hour. If additional flow capacity is required use an acetylene manifold system of sufficient size to supply the necessary volume.

## VICTOR SERIES 1 TYPE 112



- Cutting close to bulk heads
- Hand cutting of rivet heads

Metal Thickness (Inches)	Size	Part No.	Cutting Oxygen ***(psig)	Cutting Oxygen (SCFH)	Preheat Oxygen *(psig)	Preheat Oxygen (SCFH)	Acetylene (psig)	Acetylene ****(SCFH)	Speed ipm	Kerf Width
1"	2	0330-0086	35 / 40	140 / 150	4 / 9	11 / 18	3 / 6	10 / 16	15 / 19	.09
1 1/2"	2	0330-0086	40 / 45	150 / 160	4 / 12	13 / 20	3 / 7	12 / 18	13 / 17	.09

## VICTOR SERIES 1 TYPE 118 (ROUND)



- Deseaming, scarfing, gouging
- Rivet washing
- Weld preparation

Metal Thickness (Inches)	Size	Part No.	Cutting Oxygen ***(psig)	Cutting Oxygen (SCFH)	Preheat Oxygen *(psig)	Preheat Oxygen (SCFH)	Acetylene (psig)	Acetylene ****(SCFH)	Speed ipm	Kerf Width
3/8"	0	0330-0109	25 / 30	55 / 60	3 / 5	5 / 9	3 / 5	5 / 8	24 / 28	.06
1/2"	0	0330-0109	30 / 35	60 / 65	3 / 6	7 / 11	3 / 5	6 / 10	20 / 24	.06
1"	2	0330-0113	35 / 40	140 / 150	4 / 9	11 / 18	3 / 6	10 / 16	15 / 19	.09
1 1/2"	2	0330-0113	40 / 45	150 / 160	4 / 12	13 / 20	3 / 7	12 / 18	13 / 17	.09
3"	4	0330-0114	40 / 50	270 / 320	6 / 17	20 / 33	5 / 10	18 / 30	9 / 12	.12

## G-SERIES SERIES 1 TYPE 118 (ROUND)

Metal Thickness (Inches)	Size	Part no.	Model no.	Cutting Oxygen ***(psig)	Cutting Oxygen (SCFH)	Preheat Oxygen *(psig)	Preheat Oxygen (SCFH)	Acetylene (psig)	Acetylene ****(SCFH)	Speed ipm	Kerf Width
3/8"	0	6700C2700	CS11180	25 / 30	55 / 60	3 / 5	5 / 9	3 / 5	5 / 8	24 / 28	.06
1/2"	0	6700C2700	CS11180	30 / 35	60 / 65	3 / 6	7 / 11	3 / 5	6 / 10	20 / 24	.06
1"	2	6700C2701	CS11182	35 / 40	140 / 150	4 / 9	11 / 18	3 / 6	10 / 16	15 / 19	.09
1 1/2"	2	6700C2701	CS11182	40 / 45	150 / 160	4 / 12	13 / 20	3 / 7	12 / 18	13 / 17	.09
3"	4	6700C2702	CS11184	40 / 50	270 / 320	6 / 17	20 / 33	5 / 10	18 / 30	9 / 12	.12

## VICTOR SERIES 1 TYPE 118 (SIDES CUTAWAY)



- Deseaming, scarfing, gouging
- Rivet washing
- Weld preparation

Metal Thickness (Inches)	Size	Part No.	Cutting Oxygen ***(psig)	Cutting Oxygen (SCFH)	Preheat Oxygen *(psig)	Preheat Oxygen (SCFH)	Acetylene (psig)	Acetylene ****(SCFH)	Speed ipm	Kerf Width
6"	6**	0330-0115	45 / 40	500 / 600	10 / 22	33 / 48	7 / 13	30 / 44	6 / 8	.18
8"	6**	0330-0115	45 / 55	500 / 600	10 / 25	37 / 55	7 / 14	34 / 50	5 / 6	.19
12"	8**	0330-0116	45 / 55	900 / 1000	20 / 35	53 / 68	10 / 15	48 / 62	3 / 5	.41

## G-SERIES SERIES 1 TYPE 118 (SIDES CUTAWAY)

Metal Thickness (Inches)	Size	Part no.	Model no.	Cutting Oxygen ***(psig)	Cutting Oxygen (SCFH)	Preheat Oxygen *(psig)	Preheat Oxygen (SCFH)	Acetylene (psig)	Acetylene ****(SCFH)	Speed ipm	Kerf Width
6"	6**	6700C2703	CS11186	45 / 40	500 / 600	10 / 22	33 / 48	7 / 13	30 / 44	6 / 8	.18
8"	6**	6700C2703	CS11186	45 / 55	500 / 600	10 / 25	37 / 55	7 / 14	34 / 50	5 / 6	.19
12"	8**	6700C2704	CS11188	45 / 55	900 / 1000	20 / 35	53 / 68	10 / 15	48 / 62	3 / 5	.41

Data compiled using mild steel as test material.

\* Applicable for three hose machine torch only. With a two hose cutting torch, preheat pressure is set by the cutting oxygen.

\*\* For best results use ST2600FC series torches and 3/8" hose when using tip size 6 or larger.

\*\*\* All pressures are measured at the regulator using 25' x 1/4" hose through tip size 5 and 25' x 3/8" hose for tip size 6 and larger.















\*\*\*\* Oxygen consumption is 1.1 times the acetylene under neutral flame conditions.

**WARNING:** At no time should the withdrawal rate of an individual acetylene cylinder exceed 1/7 of the cylinder contents per hour. If additional flow capacity is required use an acetylene manifold system of sufficient size to supply the necessary volume.

## SERIES 1 – PROPYLENE CUTTING TIPS

### PROPYLENE

Series 1 tip style, fuel gas usage and Victor equipment compatibility shown below

Type		Fuel Gas	Application
GPP	 	P	<ul style="list-style-type: none"> <li>General purpose</li> <li>Hand and machine torch cutting</li> </ul>
HPP	 	P	<ul style="list-style-type: none"> <li>Heavy preheat for scrap, bevel and other heavy preheat requirements</li> </ul>
MTHP	 	P	<ul style="list-style-type: none"> <li>High speed machine cutting through 10" (252 mm)</li> </ul>
303MP	 	P	<ul style="list-style-type: none"> <li>General purpose</li> <li>Hand and machine torch cutting</li> </ul>
BTMP	 	P	<ul style="list-style-type: none"> <li>High performance</li> <li>Bevel cutting</li> </ul>
GTB	 	P	<ul style="list-style-type: none"> <li>Gouging tip (bent)</li> <li>Removing welds</li> </ul>
318MP	 	P	<ul style="list-style-type: none"> <li>General purpose</li> <li>Gouging and rivet washing</li> </ul>

Tip packaging is color coded with reference to fuel gas usage. Other special application tips available. Contact Technical Services at 1-800-426-1888

CUTTING TIPS





## VICTOR SERIES 1 TYPE GPP



- General purpose
- Hand and machine torch cutting

Metal Thickness (Inches)	Size	Part No.	Cutting Oxygen *** (psig)	Cutting Oxygen (SCFH)	Preheat Oxygen *(psig)	Preheat Oxygen (SCFH)	Fuel (psig)	Fuel **** (SCFH)	Speed ipm	Kerf Width
1/8"	000	0333-0260	20/25	12/14		23/108	3/5	5/6	24/28	0.04
1/4"	00	0333-0261	20/25	22/26		23/108	3/5	5/7	21/25	0.04
3/8"	0	0333-0262	25/30	45/55		23/108	3/5	8/10	20/24	0.06
3/8"	0	0387-0154#	25/30	45/55		23/108	3/5	8/10	20/24	0.06
1/2"	0	0333-0262	30/35	50/55		23/108	3/5	8/10	18/22	0.06
1/2"	0	0387-0154#	30/35	50/55		23/108	3/5	8/10	18/22	0.06
3/4"	1	0333-0263	30/35	70/80		23/108	4/6	10/12	15/20	0.08
3/4"	1	0387-0155#	30/35	70/80		23/108	4/6	10/12	15/20	0.08
1"	2	0333-0264	35/40	115/125	REFERENCE	23/108	4/8	12/15	14/18	0.09
1"	2	0387-0156#	35/40	115/125	PREHEAT	23/108	4/8	12/15	14/18	0.09
1 1/2"	2	0333-0264	40/45	125/135	CHART ON	23/108	5/9	12/15	12/16	0.09
2"	3	0333-0265	40/50	150/175	PAGE 63	23/108	5/9	14/18	10/14	0.10
2 1/2"	3	0333-0265	45/50	175/200		23/108	6/10	14/18	9/12	0.10
3"	4	0333-0266	45/50	210/250		23/108	8/12	16/20	8/11	0.12
4"	5	0333-0267	45/55	300/360		23/108	8/12	20/30	7/10	0.14
5"	5	0333-0267	50/55	330/360		23/108	8/12	20/30	6/9	0.14
6"	6**	0333-0268	45/55	400/500		23/153	10/15	25/35	5/7	0.17
8"	6**	0333-0268	55/65	450/500		23/153	10/15	25/35	4/6	0.18
10"	7	0333-0269	55/65	450/500		23/153	8/12	25/35	3/5	0.34
12"	8	0333-0270	60/70	450/500		23/153	10/14	25/35	3/4	0.14

## G-SERIES SERIES 1 TYPE GPP

Metal Thickness (Inches)	Size	Part no.	Model no.	Cutting Oxygen *** (psig)	Cutting Oxygen (SCFH)	Preheat Oxygen *(psig)	Preheat Oxygen (SCFH)	Fuel (psig)	Fuel **** (SCFH)	Speed ipm	Kerf Width
1/8"	000	6700C2588	CSGPP000	20/25	12/14		23/108	3/5	5/6	24/28	0.04
1/4"	00	6700C2589	CSGPP00	20/25	22/26		23/108	3/5	5/7	21/25	0.04
3/8"	0	6700C2590	CSGPP0	25/30	45/55		23/108	3/5	8/10	20/24	0.06
1/2"	0	6700C2590	CSGPP0	30/35	50/55		23/108	3/5	8/10	18/22	0.06
3/4"	1	6700C2591	CSGPP1	30/35	70/80		23/108	4/6	10/12	15/20	0.08
1"	2	6700C2592	CSGPP2	35/40	115/125		23/108	4/8	12/15	14/18	0.09
1 1/2"	2	6700C2592	CSGPP2	40/45	125/135	REFERENCE	23/108	5/9	12/15	12/16	0.09
2"	3	6700C2593	CSGPP3	40/50	150/175	PREHEAT	23/108	5/9	14/18	10/14	0.10
2 1/2"	3	6700C2593	CSGPP3	45/50	175/200	CHART ON	23/108	6/10	14/18	9/12	0.10
3"	4	6700C2594	CSGPP4	45/50	210/250	PAGE 63	23/108	8/12	16/20	8/11	0.12
4"	5	6700C2595	CSGPP5	45/55	300/360		23/108	8/12	20/30	7/10	0.14
5"	5	6700C2595	CSGPP5	50/55	330/360		23/108	8/12	20/30	6/9	0.14
6"	6**	6700C2596	CSGPP6	45/55	400/500		23/153	10/15	25/35	5/7	0.17
8"	6**	6700C2596	CSGPP6	55/65	450/500		23/153	10/15	25/35	4/6	0.18
10"	7**	6700C2597	CSGPP7	55/65	450/500		23/153	8/12	25/35	3/5	0.34
12"	8**	6700C2598	CSGPP8	60/70	450/500		23/153	10/14	25/35	3/4	0.14

CUTTING TIPS

Data compiled using mild steel as test material.

\* Applicable for three hose machine torch only. With a two hose cutting torch, preheat pressure is set by the cutting oxygen.

\*\* For best results use ST2600FC series torches and 3/8" hose when using tip size 6 or larger.

\*\*\* All pressures are measured at the regulator using 25' x 1/4" hose through tip size 5 and 25' x 3/8" hose for tip size 6 and larger.

\*\*\*\* Oxygen consumption is 1.1 times the acetylene under neutral flame conditions.

# Clam Shell Packaging

## G-SERIES SERIES 1 TYPE GPP-P (PLATED)



- General purpose
- Two-piece
- Medium preheat

Metal Thickness (Inches)	Size	Part no.	Model no.	Cutting Oxygen ***(psig)	Cutting Oxygen (SCFH)	Preheat Oxygen *(psig)	Preheat Oxygen (SCFH)	Fuel (psig)	Fuel ****(SCFH)	Speed ipm	Kerf Width	
1/4"	00	6700C2949	CSGPPP00	20/25	22/26			23/108	3/5	5/7	21/25	0.04
3/8"	0	6700C2950	CSGPPP0	25/30	45/55			23/108	3/5	8/10	20/24	0.06
1/2"	0	6700C2950	CSGPPP0	30/35	50/55			23/108	3/5	8/10	18/22	0.06
3/4"	1	6700C2951	CSGPPP1	30/35	70/80			23/108	4/6	10/12	15/20	0.08
1"	2	6700C2952	CSGPPP2	35/40	115/125			23/108	4/8	12/15	14/18	0.09
1 1/2"	2	6700C2952	CSGPPP	40/45	125/135	REFERENCE		23/108	5/9	12/15	12/16	0.09
2"	3	6700C2953	CSGPPP3	40/50	150/175	PREHEAT		23/108	5/9	14/18	10/14	0.10
2 1/2"	3	6700C2953	CSGPPP3	45/50	175/200	CHART ON		23/108	6/10	14/18	9/12	0.10
3"	4	6700C2954	CSGPPP4	45/50	210/250	PAGE 63		23/108	8/12	16/20	8/11	0.12
4"	5	6700C2955	CSGPPP5	45/55	300/360			23/108	8/12	20/30	7/10	0.14
5"	5	6700C2955	CSGPPP5	50/55	330/360			23/108	8/12	20/30	6/9	0.14
6"	6**	6700C2956	CSGPPP6	45/55	400/500			23/153	10/15	25/35	5/7	0.17
8"	6**	6700C2956	CSGPPP6	55/65	450/500			23/153	10/15	25/35	4/6	0.18
10"	7**	6700C2957	CSGPPP7	55/65	450/500			23/153	8/12	25/35	3/5	0.34

## VICTOR SERIES 1 TYPE HPP



- Heavy preheat
- Scrap and bevel
- Hand and machine cutting

Metal Thickness (Inches)	Size	Part No.	Cutting Oxygen *** (psig)	Cutting Oxygen (SCFH)	Preheat Oxygen *(psig)	Preheat Oxygen (SCFH)	Fuel (psig)	Fuel **** (SCFH)	Speed ipm	Kerf Width	
1/2"	0	0333-0282	30/35	70/80			44/240	3/5	22/110	18/22	0.06
3/4"	1	0333-0283	30/35	70/80			44/240	3/6	22/110	15/20	0.08
1"	2	0333-0284	35/40	115/125			44/240	3/6	22/110	14/18	0.09
1 1/2"	2	0333-0284	40/45	125/135			44/240	4/8	22/110	12/16	0.09
2"	3	0333-0285	40/45	150/175			44/240	4/8	22/110	10/14	0.10
2 1/2"	3	0333-0285	45/50	175/200	REFERENCE		44/240	5/9	22/110	9/12	0.10
3"	4	0333-0286	40/50	210/250	PREHEAT		44/240	6/9	22/110	8/11	0.12
4"	5	0333-0287	45/55	300/360	CHART ON		44/240	6/9	22/110	7/10	0.14
5"	5	0333-0287	50/55	330/360	PAGE 63		44/240	6/10	22/110	6/9	0.14
6"	6**	0333-0288	45/55	400/500			44/240	6/10	22/110	5/7	0.17
8"	6**	0333-0288	55/65	450/500			44/240	8/12	22/110	4/6	0.18
12"	8**	0333-0290	60/70	750/850			50/265	10/14	25/120	3/4	0.41
15"	10**	0333-0291	45/55	1000/1200			50/265	10/16	25/120	2/4	--
18"	12**	0333-0292	45/55	1150/1350			60/290	10/16	30/130	2/3	--

## G-SERIES SERIES 1 TYPE HPP

Metal Thickness (Inches)	Size	Part no.	Model no.	Cutting Oxygen *** (psig)	Cutting Oxygen (SCFH)	Preheat Oxygen *(psig)	Preheat Oxygen (SCFH)	Fuel (psig)	Fuel **** (SCFH)	Speed ipm	Kerf Width	
3/4"	1	6700C2901	CSHPP1	30/35	70/80			44/240	3/6	22/110	15/20	0.08
1"	2	6700C2902	CSHPP2	35/40	115/125			44/240	3/6	22/110	14/18	0.09
1 1/2"	2	6700C2902	CSHPP2	40/45	125/135			44/240	4/8	22/110	12/16	0.09
2"	3	6700C2903	CSHPP3	40/45	150/175			44/240	4/8	22/110	10/14	0.10
2 1/2"	3	6700C2903	CSHPP3	45/50	175/200	REFERENCE		44/240	5/9	22/110	9/12	0.10
3"	4	6700C2904	CSHPP4	40/50	210/250	PREHEAT		44/240	6/9	22/110	8/11	0.12
4"	5	6700C2905	CSHPP5	45/55	300/360	CHART ON		44/240	6/9	22/110	7/10	0.14
5"	5	6700C2905	CSHPP5	50/55	330/360	PAGE 63		44/240	6/10	22/110	6/9	0.14
6"	6**	6700C2906	CSHPP6	45/55	400/500			44/240	6/10	22/110	5/7	0.17
8"	6**	6700C2906	CSHPP6	55/65	450/500			44/240	8/12	22/110	4/6	0.18
10"	7**	6700C2907	CSHPP7	55/65	450/500			23/153	5/12	25/35	3/5	0.34
12"	8**	6700C2908	CSHPP8	60/70	750/850			50/265	10/14	25/120	3/4	0.41

Data compiled using mild steel as test material.

\* Applicable for three hose machine torch only. With a two hose cutting torch, preheat pressure is set by the cutting oxygen.

\*\* For best results use ST2600FC series torches and 3/8" hose when using tip size 6 or larger.

\*\*\* All pressures are measured at the regulator using 25' x 1/4" hose through tip size 5 and 25' x 3/8" hose for tip size 6 and larger.

\*\*\*\* Oxygen consumption is 1.1 times the acetylene under neutral flame conditions.

## VICTOR SERIES 1 TYPE MTHP



- High speed machines cutting up to 8" (203.2 mm)
- Two-piece
- Medium preheat

Metal Thickness (Inches)	Size	Part No.	Cutting Oxygen ***(psig)	Cutting Oxygen (SCFH)	Preheat Oxygen *(psig)	Preheat Oxygen (SCFH)	Fuel (psig)	Fuel ****(SCFH)	Speed ipm	Kerf Width
1/4"	00	0333-0352	85/95	68/75	30/35	23/140	8 oz +	12/65	23/30	0.05
3/8"	00	0333-0352	85/95	68/75	30/35	23/140	8 oz +	12/65	22/29	0.05
1/2"	0	0333-0353	85/95	110/120	30/35	23/140	8 oz +	12/65	20/28	0.06
3/4"	0	0333-0353	85/95	110/120	30/35	23/140	8 oz +	12/65	18/26	0.06
1"	1	0333-0354	85/95	145/160	30/35	23/140	8 oz +	12/65	17/24	0.07
1 1/4"	1	0333-0354	85/95	145/160	30/35	23/140	8 oz +	12/65	16/20	0.07
1 1/2"	1	0333-0354	85/95	145/160	30/35	23/140	8 oz +	12/65	12/16	0.07
2"	2	0333-0355	85/95	230/250	30/35	23/140	8 oz +	12/65	11/15	0.09
2 1/2"	2	0333-0355	85/95	230/250	30/35	23/140	8 oz +	12/65	10/13	0.09
3"	2	0333-0355	85/95	230/250	30/35	23/140	8 oz +	12/65	9/11	0.09
4"	3	0333-0356	85/95	285/320	30/35	23/140	8 oz +	12/65	7/10	0.11
5"	3	0333-0356	85/95	285/320	30/35	23/140	8 oz +	12/65	6/8	0.11
6"	3	0333-0356	85/95	285/320	30/35	23/140	8 oz +	12/65	5/7	0.11
7"	4	0333-0357	85/95	390/450	30/35	23/140	8 oz +	12/65	5/6	0.14
8"	4	0333-0357	85/95	390/450	30/35	23/140	8 oz +	12/65	4/6	0.14
9"	5	0333-0358	85/95	670/720	30/35	23/140	8 oz +	12/65	4/5	0.18
10"	5	0333-0358	85/95	670/720	30/35	23/140	8 oz +	12/65	3/5	0.18

## G-SERIES SERIES 1 TYPE MTHP

Metal Thickness (Inches)	Size	Part no.	Model no.	Cutting Oxygen ***(psig)	Cutting Oxygen (SCFH)	Preheat Oxygen *(psig)	Preheat Oxygen (SCFH)	Fuel (psig)	Fuel ****(SCFH)	Speed ipm	Kerf Width
1/4"	00	6700C3119	CSMTHP00	85/95	68/75	30/35	23/140	8 oz +	12/65	23/30	0.05
3/8"	00	6700C3119	CSMTHP00	85/95	68/75	30/35	23/140	8 oz +	12/65	22/29	0.05
1/2"	0	6700C3120	CSMTHP0	85/95	110/120	30/35	23/140	8 oz +	12/65	20/28	0.06
3/4"	0	6700C3120	CSMTHP0	85/95	110/120	30/35	23/140	8 oz +	12/65	18/26	0.06
1"	1	6700C3121	CSMTHP1	85/95	145/160	30/35	23/140	8 oz +	12/65	17/24	0.07
1 1/4"	1	6700C3121	CSMTHP1	85/95	145/160	30/35	23/140	8 oz +	12/65	16/20	0.07
1 1/2"	1	6700C3121	CSMTHP1	85/95	145/160	30/35	23/140	8 oz +	12/65	12/16	0.07
2"	2	6700C3122	CSMTHP2	85/95	230/250	30/35	23/140	8 oz +	12/65	11/15	0.09
2 1/2"	2	6700C3122	CSMTHP2	85/95	230/250	30/35	23/140	8 oz +	12/65	10/13	0.09
3"	2	6700C3122	CSMTHP2	85/95	230/250	30/35	23/140	8 oz +	12/65	9/11	0.09
4"	3	6700C3123	CSMTHP3	85/95	285/320	30/35	23/140	8 oz +	12/65	7/10	0.11
5"	3	6700C3123	CSMTHP3	85/95	285/320	30/35	23/140	8 oz +	12/65	6/8	0.11
6"	3	6700C3123	CSMTHP3	85/95	285/320	30/35	23/140	8 oz +	12/65	5/7	0.11
7"	4	6700C3124	CSMTHP4	85/95	390/450	30/35	23/140	8 oz +	12/65	5/6	0.14
8"	4	6700C3124	CSMTHP4	85/95	390/450	30/35	23/140	8 oz +	12/65	4/6	0.14
9"	5	6700C3125	CSMTHP5	85/95	670/720	30/35	23/140	8 oz +	12/65	4/5	0.18
10"	5	6700C3125	CSMTHP5	85/95	670/720	30/35	23/140	8 oz +	12/65	3/5	0.18

CUTTING TIPS

Data compiled using mild steel as test material.

\* Applicable for three hose machine torch only. With a two hose cutting torch, preheat pressure is set by the cutting oxygen.

\*\* For best results use ST2600FC series torches and 3/8" hose when using tip size 6 or larger.

\*\*\* All pressures are measured at the regulator using 25' x 1/4" hose through tip size 5 and 25' x 3/8" hose for tip size 6 and larger.

\*\*\*\* Oxygen consumption is 1.1 times the acetylene under neutral flame conditions.

## VICTOR SERIES 1 TYPE 303MP



- General purpose
- Hand and machine torch cutting

Metal Thickness (Inches)	Size	Part No.	Cutting Oxygen ***(psig)	Cutting Oxygen (SCFH)	Preheat Oxygen *(psig)	Preheat Oxygen (SCFH)	Fuel (psig)	Fuel ****(SCFH)	Speed ipm	Kerf Width
1/4"	00	0330-0187	20/25	22/26		23/108	3/5	5/7	21/25	0.04
3/8"	0	0330-0188	25/30	45/55		23/108	3/5	8/10	20/24	0.06
1/2"	0	0330-0188	30/35	50/55		23/108	3/5	8/10	18/22	0.06
3/4"	1	0330-0189	30/35	70/80		23/108	4/6	10/12	15/20	0.08
1"	2	0330-0193	35/40	115/125		23/108	4/8	12/15	14/18	0.09
1 1/2"	2	0330-0193	40/45	125/135	REFERENCE PREHEAT CHART ON PAGE 63	23/108	5/9	12/15	12/16	0.09
2"	3	0330-0194	40/45	150/175		23/108	5/9	14/18	10/14	0.10
2 1/2"	3	0330-0194	45/50	175/200		23/108	6/10	14/18	9/12	0.10
3"	4	0330-0195	45/50	210/250		23/108	8/12	16/20	8/11	0.12
4"	5	0330-0196	45/55	300/360		23/108	8/12	20/30	7/10	0.14
5"	5	0330-0196	50/55	330/360		23/108	8/12	20/30	6/9	0.14
6"	6**	0330-0197	45/55	400/500		23/153	10/15	25/35	5/7	0.17
8"	6**	0330-0197	55/65	450/500		23/153	10/15	25/35	4/6	0.18

## G-SERIES SERIES 1 TYPE 303MP

Metal Thickness (Inches)	Size	Part no.	Model no.	Cutting Oxygen *** (psig)	Cutting Oxygen (SCFH)	Preheat Oxygen *(psig)	Preheat Oxygen (SCFH)	Fuel (psig)	Fuel **** (SCFH)	Speed ipm	Kerf Width
3/8"	0	6700C3037	CS1303MP0	25/30	45/55		23/108	3/5	8/10	20/24	0.06
1/2"	0	6700C3037	CS1303MP0	30/35	50/55		23/108	3/5	8/10	18/22	0.06
3/4"	1	6700C3038	CS1303MP1	30/35	70/80		23/108	4/6	10/12	15/20	0.08
1"	2	6700C3039	CS1303MP2	35/40	115/125		23/108	4/8	12/15	14/18	0.09
1 1/2"	2	6700C3039	CS1303MP2	40/45	125/135	REFERENCE PREHEAT CHART ON PAGE 63	23/108	5/9	12/15	12/16	0.09
2"	3	6700C3040	CS1303MP3	40/50	150/175		23/108	5/9	14/18	10/14	0.10
2 1/2"	3	6700C3040	CS1303MP3	45/50	175/200		23/108	6/10	14/18	9/12	0.10
3"	4	6700C3041	CS1303MP4	45/50	210/250		23/108	8/12	16/20	8/11	0.12
4"	5	6700C3042	CS1303MP5	45/55	300/360		23/108	8/12	20/30	7/10	0.14
5"	5	6700C3042	CS1303MP5	50/55	330/360		23/108	8/12	20/30	6/9	0.14
6"	6**	6700C3043	CS1303MP6	45/55	400/500		23/153	10/15	25/35	5/7	0.17
8"	6**	6700C3043	CS1303MP6	55/65	450/500		23/153	10/15	25/35	4/6	0.18

CUTTING TIPS

## VICTOR SERIES 1 TYPE BTMP



- High performance
- Bevel cutting

Metal Thickness (Inches)	Size	Part No.	Cutting Oxygen *** (psig)	Cutting Oxygen (SCFH)	Preheat Oxygen *(psig)	Preheat Oxygen (SCFH)	Fuel (psig)	Fuel **** (SCFH)	Speed ipm	Kerf Width
1"	4	0333-0209	60/75	390/450	30/35	23/140	8-10	12/65	10/18	-
1 1/2"	4	0333-0209	60/75	390/450	30/35	23/140	8-10	12/65	8/16	-
2"	4	0333-0209	60/75	390/450	30/35	23/140	8-10	12/65	6/14	-
2 1/2"	4	0333-0209	60/75	390/450	30/35	23/140	8-10	12/65	5/12	-
3"	5	0333-0210	60/75	670/720	30/35	23/140	8-12	12/65	6/11	-
3 1/2"	5	0333-0210	60/75	670/720	30/35	23/140	8-12	12/65	12/65	-
4"	5	0333-0210	60/75	670/720	30/35	23/140	8-12	12/65	4/9	-
4 1/2"	5	0333-0210	60/75	670/720	30/35	23/140	8-12	12/65	4/8	-
5"	6	0333-0211	65/85	-	30/35	23/140	8-15	12/65	3/8	-
5 1/2"	6	0333-0211	65/85	-	30/35	23/140	8-15	12/65	3/7	-
6"	6	0333-0211	65/85	-	30/35	23/140	8-15	12/65	3/6	-

Data compiled using a 3 Hose Torch

Data compiled using mild steel as test material.

\* Applicable for three hose machine torch only. With a two hose cutting torch, preheat pressure is set by the cutting oxygen.

\*\* For best results use ST2600FC series torches and 3/8" hose when using tip size 6 or larger.

\*\*\* All pressures are measured at the regulator using 25' x 1/4" hose through tip size 5 and 25' x 3/8" hose for tip size 6 and larger.

\*\*\*\* Oxygen consumption is 1.1 times the acetylene under neutral flame conditions.

## VICTOR SERIES 1 TYPE GTB



- Gouging tip (bent)
- Removing welds

Metal Thickness (Inches)	Size	Part No.	Cutting Oxygen ***(psig)	Cutting Oxygen (SCFH)	Preheat Oxygen *(psig)	Preheat Oxygen (SCFH)	Fuel (psig)	Fuel ****(SCFH)	Speed ipm	Kerf Width
1/4 - 3/4"	3	0333-0414	30/65	175/200	30/65	23/108	8/10	14/18	-	-
1/4 - 3/4"	4	0333-0415	30/65	210/250	30/65	23/108	8/10	16/20	-	-

## VICTOR SERIES 1 TYPE 318MP



- General purpose
- Gouging and rivet washing
- Medium preheat

Metal Thickness (Inches)	Size	Part No.	Cutting Oxygen ***(psig)	Cutting Oxygen (SCFH)	Preheat Oxygen *(psig)	Preheat Oxygen (SCFH)	Fuel (psig)	Fuel ****(SCFH)	Speed ipm	Kerf Width
2"	3	0330-0333	40/45	150/175	REFERENCE PREHEAT CHART ON PAGE 63	23/108	5/9	14/18	10/14	0.10
2 1/2"	3	0330-0333	45/50	175/200		23/108	6/10	14/18	9/12	0.10
3"	4	0330-0335	45/50	210/250		23/108	8/12	16/20	8/11	0.12
6"	6**	0330-0336	45/55	400/500		23/153	10/15	25/35	5/7	0.17
8"	6**	0330-0336	55/65	450/500		23/153	10/15	25/35	4/6	0.18

## G-SERIES SERIES 1 TYPE 318MP

Metal Thickness (Inches)	Size	Part no.	Model no.	Cutting Oxygen ***(psig)	Cutting Oxygen (SCFH)	Preheat Oxygen *(psig)	Preheat Oxygen (SCFH)	Fuel (psig)	Fuel ****(SCFH)	Speed ipm	Kerf Width
1"	2	6700C2651	CS318MP2	35/40	115/125	REFERENCE PREHEAT CHART ON PAGE 63	44/240	3/6	22/110	14/18	0.09
1 1/2"	2	6700C2651	CS318MP2	40/45	125/135		44/240	4/8	22/110	12/16	0.09
3"	4	6700C2652	CS318MP4	40/50	210/250		44/240	6/9	22/110	8/11	0.12
6"	6**	6700C2653	CS318MP6	45/55	400/500		44/240	6/10	22/110	5/7	0.17
8"	6**	6700C2653	CS318MP6	55/65	450/500		44/240	8/12	22/110	4/6	0.18
12"	8**	6700C2654	CS318MP8	60/70	750/850		50/265	10/14	25/120	3/4	0.41



CUTTING TIPS

Data compiled using mild steel as test material.

\* Applicable for three hose machine torch only. With a two hose cutting torch, preheat pressure is set by the cutting oxygen.

\*\* For best results use ST2600FC series torches and 3/8" hose when using tip size 6 or larger.











\*\*\* All pressures are measured at the regulator using 25' x 1/4" hose through tip size 5 and 25' x 3/8" hose for tip size 6 and larger.

\*\*\*\* Oxygen consumption is 1.1 times the acetylene under neutral flame conditions.

## SERIES 1 – LP CUTTING TIPS

### LP (PROPANE / NATURAL GAS)

Series 1 tip style, fuel gas usage and Victor equipment compatibility shown below

Type		Fuel Gas	Application
200		LP	<ul style="list-style-type: none"> <li>General purpose</li> <li>Hand and machine torch cutting</li> </ul>
207		LP	<ul style="list-style-type: none"> <li>Used for "blowing" rivets</li> <li>Popular with various railroad applications</li> </ul>
218		LP	<ul style="list-style-type: none"> <li>Deseaming, scarfing, gouging</li> <li>Weld preparation, removing defective welds, washing rivets</li> </ul>
244		LP	<ul style="list-style-type: none"> <li>Cutting close to bulk heads</li> <li>Rivet cutting</li> </ul>
MCN		LP	<ul style="list-style-type: none"> <li>For application requiring extra heavy pre-heat and wide kerf</li> </ul>
GPN		LP	<ul style="list-style-type: none"> <li>General purpose</li> <li>Hand and machine torch cutting</li> </ul>
MTHN		LP	<ul style="list-style-type: none"> <li>High speed machine cutting through 10" (252 mm)</li> </ul>
HPN		LP	<ul style="list-style-type: none"> <li>Heavy preheat for scrap, bevel and other heavy preheat requirements</li> </ul>
BTN		LP	<ul style="list-style-type: none"> <li>Heavy performance bevel cutting for use with mild steel HSLA, T1 and HV-80</li> </ul>
CSN		LP	<ul style="list-style-type: none"> <li>A coarse splined scrap cutting tip for use with natural gas</li> </ul>
GTB		LP	<ul style="list-style-type: none"> <li>Gouging tip (bent)</li> <li>Removal of welds</li> </ul>

CUTTING TIPS

Tip packaging is color coded with reference to fuel gas usage. Other special application tips available. Contact Technical Services at 1-800-426-1888



### VICTOR SERIES 1 TYPE 200



- General purpose
- Hand and machine torch cutting

Metal Thickness (Inches)	Size	Part No.	Cutting Oxygen ***(psig)	Cutting Oxygen (SCFH)	Preheat Oxygen *(psig)	Preheat Oxygen (SCFH)	Fuel (psig)	Fuel ****(SCFH)	Speed ipm	Kerf Width
3/4"	1	0330-0144	30/35	70/80			4/6	10/12	15/20	0.08
1"	2	0330-0145	35/40	115/125			4/8	12/15	14/18	0.09
1 1/2"	2	0330-0145	40/45	125/135			5/9	12/15	12/16	0.09
2"	3	0330-0146	40/50	150/175	REFERENCE	23/108	5/9	14/18	10/14	0.10
2 1/2"	3	0330-0146	45/50	175/200	PREHEAT	23/108	6/10	14/18	9/12	0.10
3"	4	0330-0147	45/50	210/250	CHART ON	23/108	8/12	16/20	8/11	0.12
4"	5	0330-0148	45/55	300/360	PAGE 63	23/108	8/12	20/30	7/10	0.14
5"	5	0330-0148	50/55	330/360		23/108	8/12	20/30	6/9	0.14
6"	6**	0330-0149	45/55	400/500		23/153	10/15	25/35	5/7	0.17
8"	6**	0330-0149	55/65	450/500		23/153	10/15	25/35	4/6	0.18

### VICTOR SERIES 1 TYPE 207



- Used for "blowing" rivets
- Popular with various railroad applications

Metal Thickness (Inches)	Size	Part No.	Cutting Oxygen ***(psig)	Cutting Oxygen (SCFH)	Preheat Oxygen *(psig)	Preheat Oxygen (SCFH)	Fuel (psig)	Fuel ****(SCFH)	Speed ipm	Kerf Width	
3"	4	0330-0166	40/50	210/250	REFERENCE PREHEAT	44/240	6/9	22/110	8/11	0.12	
						CHART ON PAGE 63					

### VICTOR SERIES 1 TYPE 218



- Deseaming, scarfing, gouging
- Weld preparation, removing defective welds, washing rivets

Metal Thickness (Inches)	Size	Part No.	Cutting Oxygen ***(psig)	Cutting Oxygen (SCFH)	Preheat Oxygen *(psig)	Preheat Oxygen (SCFH)	Fuel (psig)	Fuel ****(SCFH)	Speed ipm	Kerf Width
3"	4	0330-0178	40/50	210/250		44/240	6/9	22/110	8/11	0.12
6"	6**	0330-0179	45/55	400/500	REFERENCE	44/240	6/10	22/110	5/7	0.17
8"	6**	0330-0179	55/65	450/500	PREHEAT	44/240	8/12	22/110	4/6	0.18
10"	8**	0330-0183	60/70	750/850	CHART ON	50/265	10/14	25/120	3/5	0.41
12"	10**	0330-0184	45/55	1000/1200	PAGE 63	50/265	10/16	25/120	3/4	0.41

### G-SERIES SERIES 1 TYPE 218

Metal Thickness (Inches)	Size	Part no.	Model no.	Cutting Oxygen ***(psig)	Cutting Oxygen (SCFH)	Preheat Oxygen *(psig)	Preheat Oxygen (SCFH)	Fuel (psig)	Fuel ****(SCFH)	Speed ipm	Kerf Width
3"	4	6700C2682	CS12184	40/50	210/250	REFERENCE	44/240	6/9	22/110	8/11	0.12
6"	6**	6700C2683	CS12186	45/55	400/500	PREHEAT	44/240	6/10	22/110	5/7	0.17
8"	6**	6700C2683	CS12186	55/65	450/500	CHART ON	44/240	8/12	22/110	4/6	0.18
10"	8**	6700C2684	CS12188	60/70	750/850	PAGE 63	50/265	10/14	25/120	3/5	0.41

### VICTOR SERIES 1 TYPE 244



- Cutting close to bulk heads
- Rivet cutting

Metal Thickness (Inches)	Size	Part No.	Cutting Oxygen ***(psig)	Cutting Oxygen (SCFH)	Preheat Oxygen *(psig)	Preheat Oxygen (SCFH)	Fuel (psig)	Fuel ****(SCFH)	Speed ipm	Kerf Width	
1"	2	0330-0344	35/40	115/125	REFERENCE	44/240	3/6	22/110	14/18	0.09	
1 1/2"	2	0330-0344	40/45	125/135	PREHEAT	44/240	4/8	22/110	12/16	0.09	
						CHART ON PAGE 63					

Data compiled using mild steel as test material.

\* Applicable for three hose machine torch only. With a two hose cutting torch, preheat pressure is set by the cutting oxygen.

\*\* For best results use ST2600FC series torches and 3/8" hose when using tip size 6 or larger.

\*\*\* All pressures are measured at the regulator using 25' x 1/4" hose through tip size 5 and 25' x 3/8" hose for tip size 6 and larger.

\*\*\*\* Oxygen consumption is 1.1 times the acetylene under neutral flame conditions.

## VICTOR SERIES 1 TYPE MCN



- Extra heavy preheat
- Wide kerf

Metal Thickness (Inches)	Size	Part No.	Cutting Oxygen ***(psig)	Cutting Oxygen (SCFH)	Preheat Oxygen *(psig)	Preheat Oxygen (SCFH)	Fuel (psig)	Fuel ****(SCFH)	Speed ipm	Kerf Width
6"	6**	0330-0543	45/55	400/500	REFERENCE PREHEAT CHART ON PAGE 63	44/240	6/10	22/110	5/7	0.17
8"	6**	0330-0543	55/65	450/500		44/240	8/12	22/110	4/6	0.18

## VICTOR SERIES 1 TYPE GPN



- General purpose
- Hand and machine cutting

Metal Thickness (Inches)	Size	Part No.	Cutting Oxygen *** (psig)	Cutting Oxygen (SCFH)	Preheat Oxygen *(psig)	Preheat Oxygen (SCFH)	Fuel (psig)	Fuel **** (SCFH)	Speed ipm	Kerf Width
1/8"	000	0333-0300	20/25	12/14	REFERENCE PREHEAT CHART ON PAGE 63	23/108	3/5	5/6	24/28	0.04
1/4"	00	0333-0301	20/25	22/26		23/108	3/5	5/7	21/25	0.04
3/8"	0	0333-0302	25/30	45/55		23/108	3/5	8/10	20/24	0.06
3/8"	0	0387-0172#	25/30	45/55		23/108	3/5	8/10	20/24	0.06
1/2"	0	0333-0302	30/35	50/55		23/108	3/5	8/10	18/22	0.06
1/2"	0	0387-0172#	30/35	50/55		23/108	3/5	8/10	18/22	0.06
3/4"	1	0333-0303	30/35	70/80		23/108	4/6	10/12	15/20	0.08
3/4"	1	0387-0173#	30/35	70/80		23/108	4/6	10/12	15/20	0.08
1"	2	0333-0304	35/40	115/125		23/108	4/8	12/15	14/18	0.09
1"	2	0387-0174#	35/40	115/125		23/108	4/8	12/15	14/18	0.09
1 1/2"	2	0333-0304	40/45	125/135		23/108	5/9	12/15	12/16	0.09
1 1/2"	2	0387-0174#	40/45	125/135		23/108	5/9	12/15	12/16	0.09
2"	3	0333-0305	40/50	150/175		23/108	5/9	14/18	10/14	0.10
2 1/2"	3	0333-0305	45/50	175/200		23/108	6/10	14/18	9/12	0.10
3"	4	0333-0306	45/50	210/250		23/108	8/12	16/20	8/11	0.12
4"	5	0333-0307	45/55	300/360		23/108	8/12	20/30	7/10	0.14
5"	5	0333-0307	50/55	330/360		23/108	8/12	20/30	6/9	0.14
6"	6**	0333-0308	45/55	400/500		23/153	10/15	25/35	5/7	0.17
8"	6**	0333-0308	55/65	450/500	23/153	10/15	25/35	4/6	0.18	
10"	7**	0333-0309	55/65	450/500	23/153	8/12	25/35	3/5	0.34	
12"	8**	0333-0310	60/70	450/500	23/153	10/14	25/35	3/4	0.41	

## G-SERIES SERIES 1 TYPE GPN

Metal Thickness (Inches)	Size	Part no.	Model no.	Cutting Oxygen *** (psig)	Cutting Oxygen (SCFH)	Preheat Oxygen *(psig)	Preheat Oxygen (SCFH)	Fuel (psig)	Fuel **** (SCFH)	Speed ipm	Kerf Width
1/8"	000	6700C2468	CSGPN000	20/25	12/14	REFERENCE PREHEAT CHART ON PAGE 63	23/108	3/5	5/6	24/28	0.04
1/4"	00	6700C2469	CSGPN00	20/25	22/26		23/108	3/5	5/7	21/25	0.04
3/8"	0	6700C2470	CSGPN0	25/30	45/55		23/108	3/5	8/10	20/24	0.06
1/2"	0	6700C2470	CSGPN00	30/35	50/55		23/108	3/5	8/10	18/22	0.06
3/4"	1	6700C2471	CSGPN1	30/35	70/80		23/108	4/6	10/12	15/20	0.08
1"	2	6700C2472	CSGPN2	35/40	115/125		23/108	4/8	12/15	14/18	0.09
1 1/2"	2	6700C2472	CSGPN2	40/45	125/135		23/108	5/9	12/15	12/16	0.09
2"	3	6700C2473	CSGPN3	40/50	150/175		23/108	5/9	14/18	10/14	0.10
2 1/2"	3	6700C2473	CSGPN3	45/50	175/200		23/108	6/10	14/18	9/12	0.10
3"	4	6700C2474	CSGPN4	45/50	210/250		23/108	8/12	16/20	8/11	0.12
4"	5	6700C2475	CSGPN5	45/55	300/360		23/108	8/12	20/30	7/10	0.14
5"	5	6700C2475	CSGPN5	50/55	330/360		23/108	8/12	20/30	6/9	0.14
6"	6**	6700C2476	CSGPN6	45/55	400/500		23/153	10/15	25/35	5/7	0.17
8"	6**	6700C2476	CSGPN6	55/65	450/500		23/153	10/15	25/35	4/6	0.18
10"	7**	6700C2477	CSGPN7	55/65	450/500		23/153	8/12	25/35	3/5	0.34
12"	8**	6700C2478	CSGPN8	60/70	450/500		23/153	10/14	25/35	3/4	0.41

Data compiled using mild steel as test material.

\* Applicable for three hose machine torch only. With a two hose cutting torch, preheat pressure is set by the cutting oxygen.

\*\* For best results use ST2600FC series torches and 3/8" hose when using tip size 6 or larger.

\*\*\* All pressures are measured at the regulator using 25' x 1/4" hose through tip size 5 and 25' x 3/8" hose for tip size 6 and larger.

\*\*\*\* Oxygen consumption is 1.1 times the acetylene under neutral flame conditions.

# Clam Shell Packaging



## G-SERIES SERIES 1 TYPE GPN (PLATED)



- General purpose
- Hand and machine cutting
- Two-piece
- Medium preheat

Metal Thickness (Inches)	Size	Part no.	Model no.	Cutting Oxygen *** (psig)	Cutting Oxygen (SCFH)	Preheat Oxygen *(psig)	Preheat Oxygen (SCFH)	Fuel (psig)	Fuel **** (SCFH)	Speed ipm	Kerf Width
1/8"	000	6700C2928	CSGPNP000	20/25	12/14		23/108	3/5	5/6	24/28	0.04
1/4"	00	6700C2929	CSGPNP00	20/25	22/26		23/108	3/5	5/7	21/25	0.04
3/8"	0	6700C2930	CSGPNP0	25/30	45/55		23/108	3/5	8/10	20/24	0.06
1/2"	0	6700C2930	CSGPNP0	30/35	50/55		23/108	3/5	8/10	18/22	0.06
3/4"	1	6700C2931	CSGPNP1	30/35	70/80		23/108	4/6	10/12	15/20	0.08
1"	2	6700C2932	CSGPNP2	35/40	115/125		23/108	4/8	12/15	14/18	0.09
1 1/2"	2	6700C2932	CSGPNP2	40/45	125/135	REFERENCE	23/108	5/9	12/15	12/16	0.09
2"	3	6700C2933	CSGPNP3	40/50	150/175	PREHEAT	23/108	5/9	14/18	10/14	0.10
2 1/2"	3	6700C2933	CSGPNP3	45/50	175/200	CHART ON	23/108	6/10	14/18	9/12	0.10
3"	4	6700C2934	CSGPNP4	45/50	210/250	PAGE 63	23/108	8/12	16/20	8/11	0.12
4"	5	6700C2935	CSGPNP5	45/55	300/360		23/108	8/12	20/30	7/10	0.14
5"	5	6700C2935	CSGPNP6	50/55	330/360		23/108	8/12	20/30	6/9	0.14
6"	6**	6700C2936	CSGPNP6	45/55	400/500		23/153	10/15	25/35	5/7	0.17
8"	6**	6700C2936	CSGPNP6	55/65	450/500		23/153	10/15	25/35	4/6	0.18
10"	7**	6700C2937	CSGPNP7	55/65	450/500		23/153	8/12	25/35	3/5	0.34
12"	8**	6700C2938	CSGPNP8	60/70	450/500		23/153	10/14	25/35	3/4	0.41

## VICTOR SERIES 1 TYPE MTHN



- High speed machine cutting through 10" (252 mm)

Metal Thickness (Inches)	Size	Part No.	Cutting Oxygen *** (psig)	Cutting Oxygen (SCFH)	Preheat Oxygen *(psig)	Preheat Oxygen (SCFH)	Fuel (psig)	Fuel **** (SCFH)	Speed ipm	Kerf Width
1/4"	00	0333-0363	85/95	68/75	30/35	23/140	8 oz +	12/65	23/30	0.05
3/8"	00	0333-0363	85/95	68/75	30/35	23/140	8 oz +	12/65	22/29	0.05
1/2"	0	0333-0364	85/95	110/120	30/35	23/140	8 oz +	12/65	20/28	0.06
3/4"	0	0333-0364	85/95	110/120	30/35	23/140	8 oz +	12/65	18/26	0.06
1"	1	0333-0365	85/95	145/160	30/35	23/140	8 oz +	12/65	17/24	0.07
1 1/4"	1	0333-0365	85/95	145/160	30/35	23/140	8 oz +	12/65	16/20	0.07
1 1/2"	1	0333-0365	85/95	145/160	30/35	23/140	8 oz +	12/65	12/16	0.07
2"	2	0333-0366	85/95	230/250	30/35	23/140	8 oz +	12/65	11/15	0.09
2 1/2"	2	0333-0366	85/95	230/250	30/35	23/140	8 oz +	12/65	10/13	0.09
3"	2	0333-0366	85/95	230/250	30/35	23/140	8 oz +	12/65	9/11	0.09
4"	3	0333-0367	85/95	285/320	30/35	23/140	8 oz +	12/65	7/10	0.11
5"	3	0333-0367	85/95	285/320	30/35	23/140	8 oz +	12/65	6/8	0.11
6"	3	0333-0367	85/95	285/320	30/35	23/140	8 oz +	12/65	5/7	0.11
7"	4	0333-0368	85/95	390/450	30/35	23/140	8 oz +	12/65	5/6	0.14
8"	4	0333-0368	85/95	390/450	30/35	23/140	8 oz +	12/65	4/6	0.14
9"	5	0333-0369	85/95	670/720	30/35	23/140	8 oz +	12/65	4/5	0.18
10"	5	0333-0369	85/95	670/720	30/35	23/140	8 oz +	12/65	3/5	0.18
-	6**	0333-0370	85/95	-	30/35	23/140	8 oz +	12/65	-	-
-	8**	0333-0371	85/95	-	30/35	23/140	8 oz +	12/65	-	-

CUTTING TIPS

Data compiled using mild steel as test material.

\* Applicable for three hose machine torch only. With a two hose cutting torch, preheat pressure is set by the cutting oxygen.

\*\* For best results use ST2600FC series torches and 3/8" hose when using tip size 6 or larger.

\*\*\* All pressures are measured at the regulator using 25' x 1/4" hose through tip size 5 and 25' x 3/8" hose for tip size 6 and larger.

\*\*\*\* Oxygen consumption is 1.1 times the acetylene under neutral flame conditions.

## G-SERIES SERIES 1 TYPE MTHN



- High speed machine cutting
- Two-piece

Metal Thickness (Inches)	Size	Part No.	Model No.	Cutting Oxygen *** (psig)	Cutting Oxygen (SCFH)	Preheat Oxygen * (psig)	Preheat Oxygen (SCFH)	Fuel (psig)	Fuel **** (SCFH)	Speed ipm	Kerf Width
1/4"	00	6700C3089	CSMTHN00	85/95	68/75	30/35	23/140	8 oz +	12/65	23/30	0.05
3/8"	00	6700C3089	CSMTHN00	85/95	68/75	30/35	23/140	8 oz +	12/65	22/29	0.05
1/2"	0	6700C3090	CSMTHN0	85/95	110/120	30/35	23/140	8 oz +	12/65	20/28	0.06
3/4"	0	6700C3090	CSMTHN0	85/95	110/120	30/35	23/140	8 oz +	12/65	18/26	0.06
1"	1	6700C3091	CSMTHN1	85/95	145/160	30/35	23/140	8 oz +	12/65	17/24	0.07
1 1/4"	1	6700C3091	CSMTHN1	85/95	145/160	30/35	23/140	8 oz +	12/65	16/20	0.07
1 1/2"	1	6700C3091	CSMTHN1	85/95	145/160	30/35	23/140	8 oz +	12/65	12/16	0.07
2"	2	6700C3092	CSMTHN2	85/95	230/250	30/35	23/140	8 oz +	12/65	11/15	0.09
2 1/2"	2	6700C3092	CSMTHN2	85/95	230/250	30/35	23/140	8 oz +	12/65	10/13	0.09
3"	2	6700C3092	CSMTHN2	85/95	230/250	30/35	23/140	8 oz +	12/65	9/11	0.09
4"	3	6700C3093	CSMTHN3	85/95	285/320	30/35	23/140	8 oz +	12/65	7/10	0.11
5"	3	6700C3093	CSMTHN3	85/95	285/320	30/35	23/140	8 oz +	12/65	6/8	0.11
6"	3	6700C3093	CSMTHN3	85/95	285/320	30/35	23/140	8 oz +	12/65	5/7	0.11
7"	4	6700C3094	CSMTHN4	85/95	390/450	30/35	23/140	8 oz +	12/65	5/6	0.14
8"	4	6700C3094	CSMTHN4	85/95	390/450	30/35	23/140	8 oz +	12/65	4/6	0.14
9"	5	6700C3095	CSMTHN5	85/95	670/720	30/35	23/140	8 oz +	12/65	4/5	0.18
10"	5	6700C3095	CSMTHN5	85/95	670/720	30/35	23/140	8 oz +	12/65	3/5	0.18
--	6**	6700C3096	CSMTHN6	85/95	-	30/35	23/140	8 oz +	12/65	-	-

## VICTOR SERIES 1 TYPE HPN



- Heavy preheat
- Snap and bevel

Metal Thickness (Inches)	Size	Part No.	Cutting Oxygen *** (psig)	Cutting Oxygen (SCFH)	Preheat Oxygen * (psig)	Preheat Oxygen (SCFH)	Fuel (psig)	Fuel **** (SCFH)	Speed ipm	Kerf Width
1/2"	0	0333-0322	30/35	70/80		44/240	3/5	22/110	18/22	0.06
3/4"	1	0333-0323	30/35	70/80		44/240	3/6	22/110	15/20	0.08
1"	2	0333-0324	35/40	115/125		44/240	3/6	22/110	14/18	0.09
1 1/2"	2	0333-0324	40/45	125/135		44/240	4/8	22/110	12/16	0.09
2"	3	0333-0325	40/45	150/175		44/240	4/8	22/110	10/14	0.10
2 1/2"	3	0333-0325	45/50	175/200	REFERENCE	44/240	5/9	22/110	9/12	0.10
3"	4	0333-0326	40/50	210/250	PREHEAT	44/240	6/9	22/110	8/11	0.12
4"	5	0333-0327	45/55	300/360	CHART ON	44/240	6/9	22/110	7/10	0.14
5"	5	0333-0327	50/55	330/360	PAGE 63	44/240	6/10	22/110	6/9	0.14
6"	6**	0333-0328	45/55	400/500		44/240	6/10	22/110	5/7	0.17
8"	6**	0333-0328	55/65	450/500		44/240	8/12	22/110	4/6	0.18
12"	8**	0333-0330	60/70	750/850		50/265	10/14	25/120	3/4	0.41
15"	10**	0333-0331	45/55	1000/1200		50/265	10/16	25/120	2/4	-
18"	12**	0333-0332	45/55	1150/1350		60/290	10/16	30/130	2/3	-

CUTTING TIPS

Data compiled using mild steel as test material.

\* Applicable for three hose machine torch only. With a two hose cutting torch, preheat pressure is set by the cutting oxygen.

\*\* For best results use ST2600FC series torches and 3/8" hose when using tip size 6 or larger.

\*\*\* All pressures are measured at the regulator using 25' x 1/4" hose through tip size 5 and 25' x 3/8" hose for tip size 6 and larger.

\*\*\*\* Oxygen consumption is 1.1 times the acetylene under neutral flame conditions.

## G-SERIES SERIES 1 TYPE HPN



- Hand and machine torch cutting
- Heavy preheat

Metal Thickness (Inches)	Size	Part No.	Model No.	Cutting Oxygen ***(psig)	Cutting Oxygen (SCFH)	Preheat Oxygen *(psig)	Preheat Oxygen (SCFH)	Fuel (psig)	Fuel ****(SCFH)	Speed ipm	Kerf Width
3/4"	1	6700C2841	CSHPN1	30/35	70/80			3/6	22/110	15/20	0.08
1"	2	6700C2842	CSMTHN2	35/40	115/125			3/6	22/110	14/18	0.09
1 1/2"	2	6700C2842	CSMTHN2	40/45	125/135			4/8	22/110	12/16	0.09
2"	3	6700C2843	CSMTHN3	40/45	150/175			4/8	22/110	10/14	0.10
2 1/2"	3	6700C2843	CSMTHN3	45/50	175/200			5/9	22/110	9/12	0.10
3"	4	6700C2844	CSMTHN4	40/50	210/250	REFERENCE	44/240	6/9	22/110	8/11	0.12
4"	5	6700C2845	CSMTHN5	45/55	300/360	PREHEAT	44/240	6/9	22/110	7/10	0.14
5"	5	6700C2845	CSMTHN5	50/55	330/360	CHART ON	44/240	6/10	22/110	6/9	0.14
6"	6**	6700C2846	CSMTHN6	45/55	400/500	PAGE 63	44/240	6/10	22/110	5/7	0.17
8"	6**	6700C2846	CSMTHN6	55/65	450/500		44/240	8/12	22/110	4/6	0.18
10"	7	6700C2847	CSMTHN7	55/65	450/500		23/153	8/12	25/35	3/5	0.34
12"	8**	6700C2848	CSMTHN8	60/70	750/850		50/265	10/14	25/120	3/4	0.41
15"	10**	6700C2849	CSMTHN10	45/55	1000/1200		50/265	10/16	25/120	2/4	-
18"	12**	6700C2850	CSMTHN12	45/55	1150/1350		60/290	10/16	30/130	2/3	-

## VICTOR SERIES 1 TYPE BTN



- Heavy performance bevel cutting for use with mild steel
- HSLA, T1 and HY-80

Metal Thickness (Inches)	Size	Part No.	Cutting Oxygen *** (psig)	Cutting Oxygen (SCFH)	Preheat Oxygen *(psig)	Preheat Oxygen (SCFH)	Fuel (psig)	Fuel **** (SCFH)	Speed ipm	Kerf Width
1	4	0333-0206	60/75	390/450	30/35	23/140	8-10	12/65	10/18	-
1.5	4	0333-0206	60/75	390/450	30/35	23/140	8-10	12/65	8/16	-
2	4	0333-0206	60/75	390/450	30/35	23/140	8-10	12/65	6/14	-
2.5	4	0333-0206	60/75	390/450	30/35	23/140	8-10	12/65	5/12	-
3	5	0333-0207	60/75	670/720	30/35	23/140	8-12	12/65	6/11	-
3.5	5	0333-0207	60/75	670/720	30/35	23/140	8-12	12/65	12/65	-
4	5	0333-0207	60/75	670/720	30/35	23/140	8-12	12/65	4/9	-
4.5	5	0333-0207	60/75	670/720	30/35	23/140	8-12	12/65	4/8	-
5	6	0333-0208	65/85	-	30/35	23/140	8-15	12/65	3/8	-
5.5	6	0333-0208	65/85	-	30/35	23/140	8-15	12/65	3/7	-
6	6	0333-0208	65/85	-	30/35	23/140	8-15	12/65	3/6	-

Data compiled using a 3 Hose Torch

## VICTOR SERIES 1 TYPE CSN



- A coarse splined scrap cutting tip
- Use with natural gas

Metal Thickness (Inches)	Size	Part No.	Cutting Oxygen *** (psig)	Cutting Oxygen (SCFH)	Preheat Oxygen *(psig)	Preheat Oxygen (SCFH)	fUEL (psig)	fUEL **** (SCFH)	Speed ipm	Kerf Width
12	8	0333-0411	60/70	750/850	REFERENCE PREHEAT CHART ON PAGE 63	50/265	10/14	25/120	3/4	0.41

## VICTOR SERIES 1 TYPE GTB



- Gouging tip

Metal Thickness (Inches)	Size	Part No.	Cutting Oxygen *** (psig)	Cutting Oxygen (SCFH)	Preheat Oxygen *(psig)	Preheat Oxygen (SCFH)	fUEL (psig)	fUEL **** (SCFH)	Speed ipm	Kerf Width
1/4 - 3/4"	3	0333-0414	30/65	175/200	30/65	23/108	8/10	14/18	-	-
1/4 - 3/4"	4	0333-0415	30/65	210/250	30/65	23/108	8/10	16/20	-	-

Data compiled using mild steel as test material.

\* Applicable for three hose machine torch only. With a two hose cutting torch, preheat pressure is set by the cutting oxygen.

\*\* For best results use ST2600FC series torches and 3/8" hose when using tip size 6 or larger.

\*\*\* All pressures are measured at the regulator using 25' x 1/4" hose through tip size 5 and 25' x 3/8" hose for tip size 6 and larger.

\*\*\*\* Oxygen consumption is 1.1 times the acetylene under neutral flame conditions.

## SERIES 3 – CUTTING TIPS

Series 3 tip style, fuel gas usage and Victor equipment compatibility shown below.

### CUTTING TORCHES

Handle	Cutting Attachment	Fuel Gas
<b>HEAVY DUTY</b>		
315FC	CA 2460-90°	All
<b>MEDIUM DUTY</b>		
100FC	CA 1350-90°, CA 1351-75°, CA 1352-180°	All
<b>LIGHT DUTY</b>		
J-40	CA 1260-90°	All
<b>STRAIGHT TORCHES</b>		
CST 800FC	-	All

### MATERIAL THICKNESS – TIP SIZE

Material Thickness		Tip Size
Inches	mm	
1/8"	3.2 mm	000
1/4"	6.4 mm	00
3/8" – 1/2"	9.5 - 12.7 mm	0
3/4"	19.1 mm	1
1" – 1 1/2"	25.4 - 38.1 mm	2
2" – 2 1/2"	50.8 - 63.5 mm	3
3"	76.2 mm	4
4" – 5"	102 - 127 mm	5

## SERIES 3 – ACETYLENE CUTTING TIPS

### VICTOR SERIES 3 TYPE 101



- General purpose
- Hand and machine torch cutting

Metal Thickness (Inches)	Size	Part No.	Cutting Oxygen *** (psig)	Cutting Oxygen (SCFH)	Preheat Oxygen *(psig)	Preheat Oxygen (SCFH)	Acetylene (psig)	Acetylene **** (SCFH)	Speed ipm	Kerf Width
1/8"	000	0331-0002	20 / 25	20 / 25	3 / 5	3 / 5	3 / 5	3 / 5	28 / 32	.04
1/4"	00	0331-0009	20 / 25	30 / 35	3 / 5	4 / 6	3 / 5	4 / 6	27 / 30	.05
1/4"	00	0387-0144#	20 / 25	30 / 35	3 / 5	4 / 6	3 / 5	4 / 6	27 / 30	.05
3/8"	0	0331-0013	25 / 30	55 / 60	3 / 5	5 / 9	3 / 5	5 / 8	24 / 28	.06
3/8"	0	0387-0145#	25 / 30	55 / 60	3 / 5	5 / 9	3 / 5	5 / 8	24 / 28	.06
1/2"	0	0331-0013	30 / 35	60 / 65	3 / 6	7 / 11	3 / 5	6 / 10	20 / 24	.06
1/2"	0	0387-0145#	30 / 35	60 / 65	3 / 6	7 / 11	3 / 5	6 / 10	20 / 24	.06
3/4"	1	0331-0014	30 / 35	80 / 85	4 / 7	9 / 14	3 / 5	8 / 13	17 / 21	.07
3/4"	1	0387-0146#	30 / 35	80 / 85	4 / 7	9 / 14	3 / 5	8 / 13	17 / 21	.07
1"	2	0331-0015	35 / 40	140 / 150	4 / 9	11 / 18	3 / 6	10 / 16	15 / 19	.09
1"	2	0387-0147#	35 / 40	140 / 150	4 / 9	11 / 18	3 / 6	10 / 16	15 / 19	.09
1 1/2"	2	0331-0015	40 / 45	150 / 160	4 / 12	13 / 20	3 / 7	12 / 18	13 / 17	.09
1 1/2"	2	0387-0147#	40 / 45	150 / 160	4 / 12	13 / 20	3 / 7	12 / 18	13 / 17	.09
2"	3	0331-0016	40 / 45	210 / 225	5 / 14	15 / 24	4 / 9	14 / 22	12 / 15	.11
2 1/2"	3	0331-0016	45 / 50	225 / 240	5 / 16	18 / 29	4 / 10	16 / 26	10 / 13	.11
3"	4	0331-0017	40 / 50	270 / 320	6 / 17	20 / 33	5 / 10	18 / 30	9 / 12	.12
4"	5	0331-0018	45 / 55	390 / 425	7 / 18	24 / 37	5 / 12	22 / 34	8 / 11	.15
5"	5	0331-0018	50 / 55	425 / 450	7 / 20	29 / 41	5 / 13	26 / 38	7 / 9	.15

### G-SERIES SERIES 3 TYPE 101

Metal Thickness (Inches)	Size	Part No.	Model No.	Cutting Oxygen *** (psig)	Cutting Oxygen (SCFH)	Preheat Oxygen *(psig)	Preheat Oxygen (SCFH)	Acetylene (psig)	Acetylene **** (SCFH)	Speed ipm	Kerf Width
1/8"	000	6700C2438	CS3101000	20 / 25	20 / 25	3 / 5	3 / 5	3 / 5	3 / 5	28 / 32	.04
1/4"	00	6700C2439	CS310100	20 / 25	30 / 35	3 / 5	4 / 6	3 / 5	4 / 6	27 / 30	.05
3/8"	0	6700C2440	CS31010	25 / 30	55 / 60	3 / 5	5 / 9	3 / 5	5 / 8	24 / 28	.06
1/2"	0	6700C2440	CS31010	30 / 35	60 / 65	3 / 6	7 / 11	3 / 5	6 / 10	20 / 24	.06
3/4"	1	6700C2441	CS31011	30 / 35	80 / 85	4 / 7	9 / 14	3 / 5	8 / 13	17 / 21	.07
1"	2	6700C2442	CS31012	35 / 40	140 / 150	4 / 9	11 / 18	3 / 6	10 / 16	15 / 19	.09
1 1/2"	2	6700C2442	CS31012	40 / 45	150 / 160	4 / 12	13 / 20	3 / 7	12 / 18	13 / 17	.09
2"	3	6700C2443	CS31013	40 / 45	210 / 225	5 / 14	15 / 24	4 / 9	14 / 22	12 / 15	.11
2 1/2"	3	6700C2443	CS31013	45 / 50	225 / 240	5 / 16	18 / 29	4 / 10	16 / 26	10 / 13	.11
3"	4	6700C2444	CS31014	40 / 50	270 / 320	6 / 17	20 / 33	5 / 10	18 / 30	9 / 12	.12
4"	5	6700C2445	CS31015	45 / 55	390 / 425	7 / 18	24 / 37	5 / 12	22 / 34	8 / 11	.15
5"	5	6700C2445	CS31015	50 / 55	425 / 450	7 / 20	29 / 41	5 / 13	26 / 38	7 / 9	.15

Data compiled using mild steel as test material.

\* Applicable for three hose machine torch only. With a two hose cutting torch, preheat pressure is set by the cutting oxygen.

\*\* For best results use ST2600FC series torches and 3/8" hose when using tip size 6 or larger.

\*\*\* All pressures are measured at the regulator using 25' x 1/4" hose through tip size 5 and 25' x 3/8" hose for tip size 6 and larger.

\*\*\*\* Oxygen consumption is 1.1 times the acetylene under neutral flame conditions.

# Clam Shell Packaging

**WARNING:** At no time should the withdrawal rate of an individual acetylene cylinder exceed 1/7 of the cylinder contents per hour. If additional flow capacity is required use an acetylene manifold system of sufficient size to supply the necessary volume.

## VICTOR SERIES 3 TYPE 118 (ROUND)



- Deseaming, scarfing, gouging
- Rivet washing
- Weld preparation

Metal Thickness (Inches)	Size	Part No.	Cutting Oxygen ***(psig)	Cutting Oxygen (SCFH)	Preheat Oxygen *(psig)	Preheat Oxygen (SCFH)	Acetylene (psig)	Acetylene ****(SCFH)	Speed ipm	Kerf Width
1"	2	0331-0035	35 / 40	140 / 150	4 / 9	11 / 18	3 / 6	10 / 16	15 / 19	.09
1 1/2"	2	0331-0035	40 / 45	150 / 160	4 / 12	13 / 20	3 / 7	12 / 18	13 / 17	.09

## G-SERIES SERIES 3 TYPE 118 (ROUND)

Metal Thickness (Inches)	Size	Part No.	Model No.	Cutting Oxygen ***(psig)	Cutting Oxygen (SCFH)	Preheat Oxygen *(psig)	Preheat Oxygen (SCFH)	Acetylene (psig)	Acetylene ****(SCFH)	Speed ipm	Kerf Width
3/8"	0	6700C2730	CS31180	25 / 30	55 / 60	3 / 5	5 / 9	3 / 5	5 / 8	24 / 28	.06
1/2"	0	6700C2730	CS31180	30 / 35	60 / 65	3 / 6	7 / 11	3 / 5	6 / 10	20 / 24	.06
1"	2	6700C2731	CS31182	35 / 40	140 / 150	4 / 9	11 / 18	3 / 6	10 / 16	15 / 19	.09
1 1/2"	2	6700C2731	CS31182	40 / 45	150 / 160	4 / 12	13 / 20	3 / 7	12 / 18	13 / 17	.09

## SERIES 3 – PROPYLENE CUTTING TIPS

### VICTOR SERIES 3 TYPE GPP



- General purpose
- Hand and machine torch cutting

Metal Thickness (Inches)	Size	Part No.	Cutting Oxygen ***(psig)	Cutting Oxygen (SCFH)	Preheat Oxygen *(psig)	Preheat Oxygen (SCFH)	Fuel (psig)	Fuel ****(SCFH)	Speed ipm	Kerf Width
1/4"	00	0333-0389	20/25	22/26		23/108	3/5	5/7	21/25	0.04
3/8"	0	0333-0390	25/30	45/55		23/108	3/5	8/10	20/24	0.06
1/2"	0	0333-0390	30/35	50/55		23/108	3/5	8/10	18/22	0.06
3/4"	1	0333-0391	30/35	70/80	REFERENCE PREHEAT CHART ON PAGE 63	23/108	4/6	10/12	15/20	0.08
1"	2	0333-0392	35/40	115/125		23/108	4/8	12/15	14/18	0.09
1 1/2"	2	0333-0392	40/45	125/135		23/108	5/9	12/15	12/16	0.09
2"	3	0333-0393	40/50	150/175		23/108	5/9	14/18	10/14	0.10
2 1/2"	3	0333-0393	45/50	175/200		23/108	6/10	14/18	9/12	0.10
3"	4	0333-0394	45/50	210/250		23/108	8/12	16/20	8/11	0.12

### G-SERIES SERIES 3 TYPE GPP

Metal Thickness (Inches)	Size	Part No.	Model No.	Cutting Oxygen ***(psig)	Cutting Oxygen (SCFH)	Preheat Oxygen *(psig)	Preheat Oxygen (SCFH)	Acetylene (psig)	Acetylene ****(SCFH)	Speed ipm	Kerf Width
1/8"	000	6700C2618	CS3GPP000	20/25	12/14		23/108	3/5	5/6	24/28	0.04
1/4"	00	6700C2619	CS3GPP00	20/25	22/26		23/108	3/5	5/7	21/25	0.04
3/8"	0	6700C2620	CS3GPP0	25/30	45/55		23/108	3/5	8/10	20/24	0.06
1/2"	0	6700C2620	CS3GPP0	30/35	50/55	REFERENCE PREHEAT CHART ON PAGE 63	23/108	3/5	8/10	18/22	0.06
3/4"	1	6700C2621	CS3GPP1	30/35	70/80		23/108	4/6	10/12	15/20	0.08
1"	2	6700C2622	CS3GPP2	35/40	115/125		23/108	4/8	12/15	14/18	0.09
1 1/2"	2	6700C2622	CS3GPP2	40/45	125/135		23/108	5/9	12/15	12/16	0.09
2"	3	6700C2623	CS3GPP3	40/45	150/175		23/108	5/9	14/18	10/14	0.10
2 1/2"	3	6700C2623	CS3GPP3	45/50	175/200		23/108	6/10	14/18	9/12	0.10
3"	4	6700C2624	CS3GPP4	45/50	210/250	23/108	8/12	16/20	8/11	0.12	

Data compiled using mild steel as test material.

\* Applicable for three hose machine torch only. With a two hose cutting torch, preheat pressure is set by the cutting oxygen.

\*\* For best results use ST2600FC series torches and 3/8" hose when using tip size 6 or larger.

\*\*\* All pressures are measured at the regulator using 25' x 1/4" hose through tip size 5 and 25' x 3/8" hose for tip size 6 and larger.

\*\*\*\* Oxygen consumption is 1.1 times the acetylene under neutral flame conditions.

**WARNING:** At no time should the withdrawal rate of an individual acetylene cylinder exceed 1/7 of the cylinder contents per hour. If additional flow capacity is required use an acetylene manifold system of sufficient size to supply the necessary volume.

## G-SERIES SERIES 3 TYPE 318MP



- General purpose
- Gouging and rivet washing

Metal Thickness (Inches)	Size	Part No.	Model No.	Cutting Oxygen ***(psig)	Cutting Oxygen (SCFH)	Preheat Oxygen *(psig)	Preheat Oxygen (SCFH)	Acetylene (psig)	Acetylene ****(SCFH)	Speed ipm	Kerf Width
1"	2	6700C2660	CS3318MP2	35/40	115/125		44/240	3/6	22/110	14/18	0.09
1 1/2"	2	6700C2660	CS3318MP2	40/45	125/135	REFERENCE	44/240	4/8	22/110	12/16	0.09
3"	4	6700C2662	CS3318MP4	40/50	210/250	PREHEAT	44/240	6/9	22/110	8/11	0.12
6"	6**	6700C2664	CS3318MP6	45/55	400/500	CHART ON	44/240	6/10	22/110	5/7	0.17
8"	6**	6700C2664	CS3318MP6	55/65	450/500	PAGE 63	44/240	8/12	22/110	4/6	0.18
12"	8**	6700C2666	CS3318MP8	60/70	750/850		50/265	10/14	25/120	3/4	0.41

## SERIES 3 – LP (PROPANE / NATURAL GAS) CUTTING TIPS

### VICTOR SERIES 3 TYPE GPN



- General purpose
- Hand and machine cutting

Metal Thickness (Inches)	Size	Part No.	Cutting Oxygen ***(psig)	Cutting Oxygen (SCFH)	Preheat Oxygen *(psig)	Preheat Oxygen (SCFH)	Fuel (psig)	Fuel ****(SCFH)	Speed ipm	Kerf Width
1/4"	00	0333-0398	20/25	22/26		23/108	3/5	5/7	21/25	0.04
1/4"	00	0387-0182#	20/25	22/26		23/108	3/5	5/7	21/25	0.04
3/8"	0	0333-0399	25/30	45/55		23/108	3/5	8/10	20/24	0.06
1/2"	0	0333-0399	30/35	50/55		23/108	3/5	8/10	18/22	0.06
3/4"	1	0333-0400	30/35	70/80		23/108	4/6	10/12	15/20	0.08
3/4"	1	0387-0184#	30/35	70/80		23/108	4/6	10/12	15/20	0.08
1"	2	0333-0401	35/40	115/125	REFERENCE	23/108	4/8	12/15	14/18	0.09
1"	2	0387-0185#	35/40	115/125	PREHEAT	23/108	4/8	12/15	14/18	0.09
1 1/2"	2	0333-0402	40/45	125/135	CHART ON	23/108	5/9	12/15	12/16	0.09
1 1/2"	2	0387-0185#	40/45	125/135	PAGE 63	23/108	5/9	12/15	12/16	0.09
2"	3	0333-0402	40/50	150/175		23/108	5/9	14/18	10/14	0.10
2 1/2"	3	0333-0402	45/50	175/200		23/108	6/10	14/18	9/12	0.10
3"	4	0333-0403	45/50	210/250		23/108	8/12	16/20	8/11	0.12
4"	5	0333-0404	45/55	300/360		23/108	8/12	20/30	7/10	0.14
5"	5	0333-0404	50/55	330/360		23/108	8/12	20/30	6/9	0.14

### G-SERIES SERIES 3 TYPE GPN

Metal Thickness (Inches)	Size	Part No.	Model No.	Cutting Oxygen ***(psig)	Cutting Oxygen (SCFH)	Preheat Oxygen *(psig)	Preheat Oxygen (SCFH)	Acetylene (psig)	Acetylene ****(SCFH)	Speed ipm.	Kerf Width
1/8"	000	6700C2498	CS3GPN000	20/25	12/14		23/108	3/5	5/6	24/28	0.04
1/4"	00	6700C2499	CS3GPN00	20/25	22/26		23/108	3/5	5/7	21/25	0.04
3/8"	0	6700C2500	CS3GPN0	25/30	45/55		23/108	3/5	8/10	20/24	0.06
1/2"	0	6700C2500	CS3GPN0	30/35	50/55		23/108	3/5	8/10	18/22	0.06
3/4"	1	6700C2501	CS3GPN1	30/35	70/80	REFERENCE	23/108	4/6	10/12	15/20	0.08
1"	2	6700C2502	CS3GPN2	35/40	115/125	PREHEAT	23/108	4/8	12/15	14/18	0.09
1 1/2"	2	6700C2502	CS3GPN2	40/45	125/135	CHART ON	23/108	5/9	12/15	12/16	0.09
2"	3	6700C2503	CS3GPN3	40/50	150/175	PAGE 63	23/108	5/9	14/18	10/14	0.10
2 1/2"	3	6700C2503	CS3GPN3	45/50	175/200		23/108	6/10	14/18	9/12	0.10
3"	4	6700C2504	CS3GPN4	45/50	210/250		23/108	8/12	16/20	8/11	0.12
4"	5	6700C2505	CS3GPN5	45/55	300/360		23/108	8/12	20/30	7/10	0.14
5"	5	6700C2505	CS3GPN5	50/55	330/360		23/108	8/12	20/30	6/9	0.14

Data compiled using mild steel as test material.

\* Applicable for three hose machine torch only. With a two hose cutting torch, preheat pressure is set by the cutting oxygen.

\*\* For best results use ST2600FC series torches and 3/8" hose when using tip size 6 or larger.

\*\*\* All pressures are measured at the regulator using 25' x 1/4" hose through tip size 5 and 25' x 3/8" hose for tip size 6 and larger.

\*\*\*\* Oxygen consumption is 1.1 times the acetylene under neutral flame conditions.

# Clam Shell Packaging

# AIRCO® CUTTING TIPS

## G-SERIES AIRCO – STYLE 144 ACETYLENE



- General purpose
- Medium preheat

Metal Thickness (Inches)	Size	Part No.	Model No.	Drill Size	Oxygen Pressure (psig)	Oxygen Pressure (SCHF)	Acetylene (psig)	Acetylene (SCFH)	Speed ipm
1/8"	00	6700C1009	CS144 00	69	30	33	1.5	11	21-24
1/4"	0	6700C1010	CS144 0	64	30	57	2	14	20-23
3/8"	1	6700C1011	CS144 1	57	30	84	3	20	18-21
3/4"	2	6700C1012	CS144 2	55	40	134	3	22	14-17
1 1/2"	3	6700C1013	CS144 3	53	45	190	3	23	11-14
2 1/2"	4	6700C1014	CS144 4	50	50	263	3	25	8-11
3"	5	6700C1015	CS144 5	47	45	313	4	31	7-10
5"	6	6700C1016	CS144 6	42	50	457	5	43	5-7
6 - 8"	8	6700C1018	CS144 8	35	50	550	7	45	5-6

## G-SERIES AIRCO – STYLE 164 ACETYLENE



- Special application
- Heavy preheat

Metal Thickness (Inches)	Size	Part No.	Model No.	Drill Size	Oxygen Pressure (psig)	Oxygen Pressure (SCHF)	Acetylene (psig)	Acetylene (SCFH)	Speed ipm
1/8"	00	6700C1039	CS164 00	69	25	33	1.5	13	22-26
5/16"	0	6700C1040	CS164 0	64	30	60	2	17	20-24
1/2"	1	6700C1041	CS164 1	57	40	105	3	25	17-20
1"	2	6700C1042	CS164 2	55	50	160	3	27	14-16
1 3/4"	3	6700C1043	CS164 3	53	50	210	3	29	11-15
2 1/2"	4	6700C1044	CS164 4	50	50	275	3	31	9-13
4"	5	6700C1045	CS164 5	47	60	400	4	45	7-10
6"	6	6700C1046	CS164 6	42	55	505	5	52	5-8
8"	7	6700C1047	CS164 7	36	60	680	6	70	4-6
10"	8	6700C1048	CS164 8	1/8	55	760	6	70	3.5 - 5
12"	10	6700C1049	CS164 10	19	65	950	10	70	3-5

## G-SERIES AIRCO – STYLE 245 (A-FS) PROPYLENE



- Two-piece
- Medium preheat

Metal Thickness (Inches)	Size	Part No.	Model No.	Drill Size	Oxygen Pressure (psig)	Oxygen Pressure (SCHF)	Acetylene (psig)	Acetylene (SCFH)	Speed ipm
3/16"	00	6700C1139	CS245 00	69	55	52	2-3	6-8	.05
1/4"	0	6700C1140	CS145 0	64	40	57	2-3	6-8	18-20
1/2"	1	6700C1141	CS245 1	57	50	98	3-4	7-10	15-19
3/4"	2	6700C1142	CS245 2	55	50	134	3-4	7-10	.09
1 1/4"	3	6700C1143	CS245 3	53	50	192	4-5	10-14	12-15
2 1/2"	4	6700C1144	CS245 4	50	50	250	4-5	10-14	9-12
3"	5	6700C1145	CS245 5	47	50	335	5-6	14-18	7-10
6"	6	6700C1146	CS245 6	42	60	584	6-7	14-18	6-7
10"	7	6700C1147	CS245 7	35	65	890	7-8	18-20	3-5
14"	8	6700C1148	CS245 8	30	70	1240	7-8	18-20	3-4

Airco is a registered trademark of Control Corps of America.

Airco is in no way affiliated with Victor® or ESAB. The parts advertised for sale are not genuine manufacturer parts, but are parts made for and by Victor and ESAB. Reference to Airco products are for your convenience only. We reserve the right to substitute genuine manufacturer parts in place of Victor parts.

## HARRIS® CUTTING TIPS

### G-SERIES HARRIS – STYLE 6290 ACETYLENE



- General purpose
- Medium preheat

Metal Thickness (Inches)	Size	Part No.	Model No.	Drill Size	Cutting Oxygen (psig)	Oxygen Pressure (SCHF)	Acetylene (psig)	Acetylene (SCFH)	Speed ipm
Light to 3/16"	000	6700C1428	CS2629 000	68	15-20	20-25	3-5	3-5	25-30
3/8 - 3/16"	00	6700C1429	CS62690 00	64	20-25	30-35	3-5	4-6	25-30
3/16 - 5/8"	0	6700C1430	CS6290 0	60	35-40	60-65	3-5	5-8	24-28
5/8 - 1"	1	6700C1431	CS6290 1	56	35-40	75-85	3-5	6-10	20-24
1 - 2"	2	6700C1432	CS6290 2	54	40-45	160-175	3-7	8-13	17-21
2 - 3"	3	6700C1433	CS6290 3	48	45-50	250-270	4-10	10-16	12-15
4 - 6"	4	6700C1434	CS6290 4	42	50-75	425-575	5-10	16-26	9-12
6 - 8"	5	6700C1435	CS6290 5	35	65-80	650-800	5-12	22-34	8-11
8 - 12"	6	6700C1436	CS6290 6	30	70-90	900-1100	5-13	26-38	5-6

### G-SERIES HARRIS – STYLE 6290 GG LP GAS



- Special application
- Heavy preheat

Metal Thickness (Inches)	Size	Part No.	Model No.	Drill Size	Cutting Oxygen (psig)	Oxygen Pressure (SCHF)	Fuel (psig)	Fuel (SCFH)	Speed ipm
1/8 - 1/4"	1	6700C1551	CS6290GG 1	56	35	85	4-6	10-12	--
3/16 - 3/8"	2	6700C1552	CS6290GG 2	54	50	175	5-9	12-15	--
1/4 - 1/2"	3	6700C1533	CS6290GG 3	48	50	270	6-10	14-18	--

### G-SERIES HARRIS – STYLE 6290 NX LP GAS



- Two-piece
- Medium preheat

Metal Thickness (Inches)	Size	Part No.	Model No.	Drill Size	Cutting Oxygen (psig)	Oxygen Pressure (SCHF)	Fuel (psig)	Fuel (SCFH)	Speed ipm
3/16 - 3/8"	00	6700C1509	CS6290NX 00	64	20-30	30-40	35	8	--
3/8 - 5/8"	0	6700C1510	CS6290NX 0	60	30-40	56-65	35	8	--
5/8 - 1"	1	6700C1511	CS6290NX 1	56	35-40	75-100	35	8	--
1 - 2"	2	6700C1512	CS6290NX 2	52	40-55	160-210	40	10	--
2 - 3"	3	6700C1513	CS6290NX 3	48	45-60	250-325	40	10	--
3 - 6"	4	6700C1514	CS6290NX 4	42	50-75	425-575	50	12	--
6 - 8"	5	6700C1515	CS6290NX 5	35	65-80	650-800	60	15	--
8 - 12"	6	6700C1516	CS6290NX 6	30	70-90	900-1100	70	17	--

CUTTING TIPS

Harris is a registered trademark of the Lincoln Electric Company.

Harris is in no way affiliated with Victor® or ESAB. The parts advertised for sale are not genuine manufacturer parts, but are parts made for and by Victor and ESAB. Reference to Harris products are for your convenience only. We reserve the right to substitute genuine manufacturer parts in place of Victor parts.



# SMITH® CUTTING TIPS

## G-SERIES SMITH – STYLE SC-12 ACETYLENE



- General purpose
- Hand and machine cutting
- Medium preheat

Metal Thickness (Inches)	Size	Part No.	Model No.	Drill Size	Oxygen Pressure (psig)	Oxygen Pressure (SCFH)	Acetylene (psig)	Acetylene (SCFH)	Speed ipm
Light	000	6700C2188	CSSC12 000	70	20	24	10	6.5	24
3/16"	00	6700C2189	CSSC12 00	68	20	24	10	6.5	26
1/4 - 3/8"	0	6700C2190	CSSC12 0	62	30-35	40-50	10	7	20-22
1/2 - 5/8"	1	6700C2191	CSSC12 1	56	35-45	75-85	10	9.5	17-19
3/4 - 1 1/4"	2	6700C2192	CSSC12 2	54	35-50	105-135	10	10.5	13-16
1 1/2 - 2"	3	6700C2193	CSSC12 3	51	40-45	170-180	10	12	10-12
2 1/2 - 4"	4	6700C2197	CSSC12 4	45	35-50	240-315	10	13-14	7-9
5 - 6"	5	6700C2195	CSSC12 5	41	50-70	420-550	10	26	5.5-7
10 - 12"	6	6700C2196	CSSC12 6	32	70-90	750-975	10	28	4.5-5
12"	7	6700C2197	CSSC12 7	30	70-90	850-975	10	28	4.5

## G-SERIES SMITH – STYLE SC-50 LP GAS



- Special application
- Scrap cutting and beveling
- Heavy preheat
- Two-piece

Metal Thickness (Inches)	Size	Part No.	Model No.	Drill Size	Oxygen Pressure (psig)	Oxygen Pressure (SCFH)	Fuel (psig)	Fuel (SCFH)	Speed ipm
3/16"	00	6700C2249	CSSC50 00	68	25	12-14	3-5	5-6	23-27
1/4 - 3/8"	0	6700C2250	CSSC50 0	62	30-35	40-50	3-5	5-7	20-22
1/2 - 5/8"	1	6700C2251	CSSC50 1	56	35-40	75-85	3-5	8-10	17-19
3/4 - 1 1/4"	2	6700C2252	CSSC50 2	54	35-50	105-135	4-8	8-10	13-16
1 1/2 - 2"	3	6700C2253	CSSC50 3	51	40-45	170-180	5-9	10-12	10-12
2 1/2 - 4"	4	6700C2254	CSSC50 4	45	35-50	240-315	8-12	12-15	7-9
5 - 8"	5	6700C2255	CSSC50 5	41	50-70	420-550	8-12	12-15	5-7
10 - 12"	6	6700C2256	CSSC50 6	32	70-90	750-975	8-12	14-18	4.5-5
14"	7	6700C2257	CSSC50 7	28	90	1250	8-12	20-30	4.0
16 - 18"	8	6700C2258	CSSC50 8	17	90	1500-1800	10-15	25-35	3.5
20"	9	6700C2259	CSSC50 9	3	90	2150	10-15	25-35	3.0

## G-SERIES SMITH – STYLE SC-60 PROPYLENE



- General purpose
- Hand and machine cutting
- Medium preheat
- Two-piece

Metal Thickness (Inches)	Size	Part No.	Model No.	Drill Size	Oxygen Pressure (psig)	Oxygen Pressure (SCFH)	Fuel (psig)	Fuel (SCFH)	Speed ipm
1/8"	00	6700C2309	CSSC60 00	68	20-25	12-14	3-5	5-6	23-27
1/4 - 3/8"	0	6700C2310	CSSC60 0	62	30-35	40-50	3-5	8-10	20-22
1/2 - 5/8"	1	6700C2311	CSSC60 1	56	35-40	75-85	4-6	10-12	17-19
3/4 - 1 1/2"	2	6700C2312	CSSC60 2	54	35-50	105-135	4-8	12-15	13-16
1 1/2 - 2"	3	6700C2313	CSSC60 3	51	40-45	170-180	6-10	14-18	10-12
2 1/2 - 4"	4	6700C2314	CSSC60 4	45	35-50	240-315	8-12	16-20	7-9
5 - 8"	5	6700C2315	CSSC60 5	41	50-70	420-550	8-12	20-30	5-7
10 - 12"	6	6700C2316	CSSC60 6	32	70-90	750-975	10-15	25-35	4.5-5

Smith is a registered trademark of Smith Equipment Manufacturing Co.

Smith is in no way affiliated with Victor® or ESAB. The parts advertised for sale are not genuine manufacturer parts, but are parts made for and by Victor and ESAB. Reference to Smith products are for your convenience only. We reserve the right to substitute genuine manufacturer parts in place of Victor parts.

## VICTOR MACHINE TORCHES

They are available in two and three hose versions. Two hose torches are available in 4.5" (114.3 mm), 10" (254.0 mm) and 18" (457.2 mm) models, and three hose torches are available in 10" (254.0 mm) and 18" (457.2 mm) models.

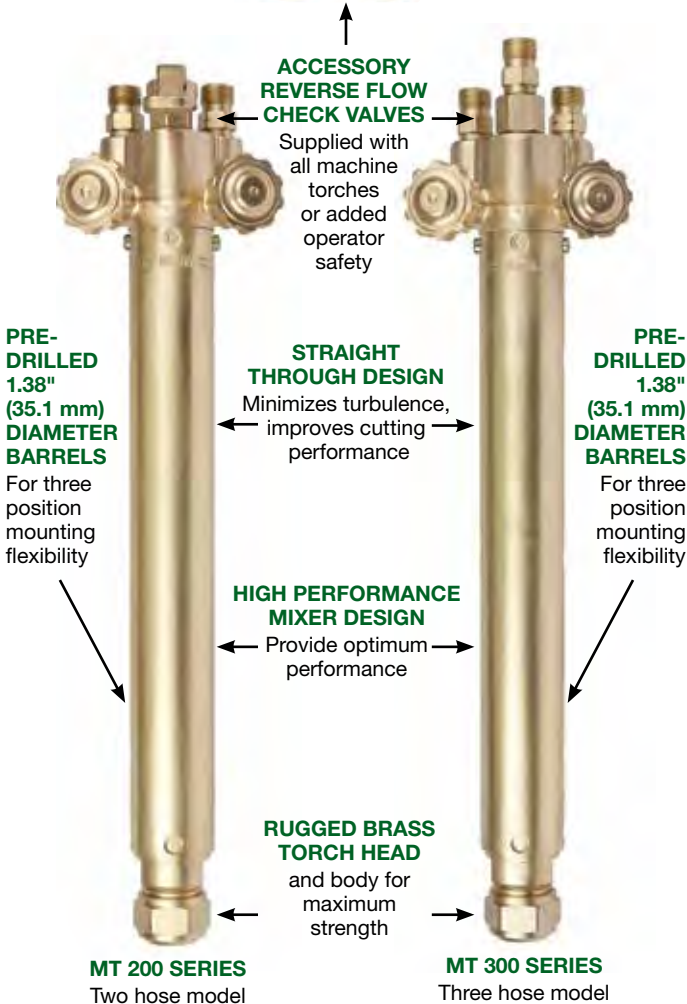
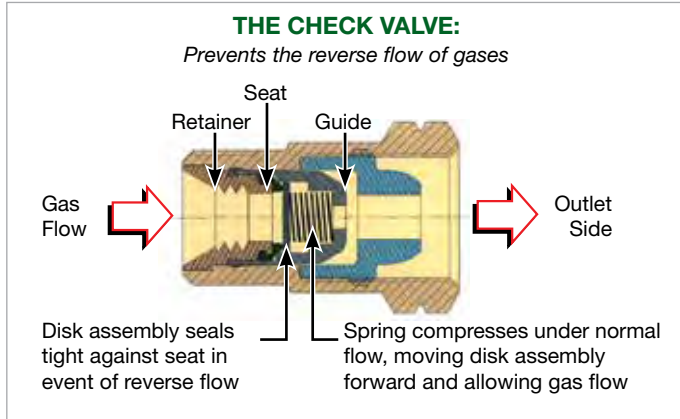

MACHINE TORCHES

## STRAIGHT CUTTING TORCHES & CUTTING MACHINE REFERENCE GUIDE

Torch Model	Tip Series	Fuel Gas Usage	Cut Capacity
<b>"FC" MODELS</b>			
ST 2600FC VanGuard™	1	Any Fuel Gas	1/8" to 8" (3.2 mm to 203.2 mm)
ST 1000FC VanGuard	1	Any Fuel Gas	1/8" to 5" (3.2 mm to 127.0 mm)
ST 900FC VanGuard	1	Any Fuel Gas	1/8" to 5" (3.2 mm to 127.0 mm)
<b>MACHINE TORCHES</b>			
MT 200 (2 Hose)	1	Any Fuel Gas	7" (177.8 mm)
MT 300 (3 Hose)	1	Any Fuel Gas	12" (304.8 mm)
MT 1065 (3 Hose)	1	Any Fuel Gas	7" (177.8 mm)
MT 5 (3 Hose)	1	Any Fuel Gas	7" (177.8 mm)

### TIP TYPE –

BTN for use with Natural Gas & Propane.

BTMP for use with Propylene Gases

(For use with MT200, MT300 Series Machine Cutting Torches)

Length of Bevel	Tip Size	Speed IPM	Oxygen Pressure	Fuel Pressure	Cutting Oxygen Pressure
<b>MT 200 SERIES</b>					
1	4	10/18	60/75	8/10	–
1.5	4	8/16	60/75	8/10	–
2	4	6/14	60/75	8/10	–
2.5	4	5/12	60/75	8/10	–
3	5	6/11	60/75	8/12	–
3.5	5	5/10	60/75	8/12	–
4	5	4/9	60/75	8/12	–
4.5	5	4/8	60/75	8/12	–
5	6	3/8	65/85	8/15	–
5.5	6	3/7	65/85	8/15	–
6	6	3/6	65/85	8/15	–
<b>MT 300N SERIES</b>					
1	4	10/18	35/65	10/12	40/60
1.5	4	8/16	35/65	10/12	40/60
2	4	6/14	35/65	10/12	40/60
2.5	4	5/12	35/65	10/12	40/60
3	5	6/11	35/65	10/12	40/65
3.5	5	5/10	35/65	10/12	40/65
4	5	4/9	35/65	10/12	40/65
4.5	5	4/8	35/65	10/12	40/65
5	6	3/8	35/65	10/12	40/75
5.5	6	3/7	35/65	10/12	40/75
6	6	3/6	35/65	10/12	40/75

Bevels of 30° to 70° are possible on mild steel and most alloy steel without a preheat attachment. High gas withdrawal rates will require manifolding. Consult your gas supplier.

Victor® machine cutting torches are available in two and three hose models. Three hose torches are high performance “straight through” design that minimizes turbulence and improves cut quality. Accessory reverse flow check valves are supplied for use at the torches inlet connection. All machine torches use Series 1 cutting tips and are supplied with accessory reverse flow check valves to be used on the torch inlet connections.

## MT 200 Series

### TWO HOSE



- Cut capacity: 7" (177.8 mm)
- Series 1 cutting tips

Part No.	Model No.	Total Length	Barrel Length	Racking Length	Gas
0380-0215	MT 204A	8.5" (215.9 mm)	4.5" (114.3 mm)	–	*Acetylene
0397-0217	MT 204A***	8.5" (215.9 mm)	4.5" (114.3 mm)	–	*Acetylene
0380-0217	MT 210A	14" (355.6 mm)	10" (254.0 mm)	7" (177.8 mm)	*Acetylene
0380-0216	MT 210N	14" (355.6 mm)	10" (254.0 mm)	7" (177.8 mm)	**LP/Natural Gas

\*May also be used on other pressurized fuel gases  
 \*\*May also be used on other fuel gases except acetylene  
 \*\*\*Supplied with rack soldered to barrel  
 Other machine torch models available. Ask for details  
 Gear racks: Must be ordered separately

## MT 1065

### THREE HOSE



- Cut capacity: 7" (177.8 mm)
- For use with all fuel gases
- Series 1 cutting tips
- Multi-torch beveling

Part No.	Model No.	Total Length	Barrel Diameter	Barrel Length	Racking Length	Gas
0399-1065	MT 1065N	8" (203.2 mm)	1.25" (31.8 mm)	4" (101.6 mm)	–	All
0399-1121	MT 1065A	8" (203.2 mm)	1.25" (31.8 mm)	4" (101.6 mm)	–	Acetylene

## MT 300 Series

### THREE HOSE



- Cut capacity: 12" (304.8 mm)
- Series 1 cutting tips

Part No.	Model No.	Total Length	Barrel Length	Racking Length	Gas
0380-0222	MT 310A	14" (355.6 mm)	10" (254.0 mm)	7" (177.8 mm)	*Acetylene
0380-0220	MT 310N	14" (355.6 mm)	10" (254.0 mm)	7" (177.8 mm)	**LP/Natural Gas
0380-0221	MT 310NV	14" (355.6 mm)	10" (254.0 mm)	7" (177.8 mm)	**LP/Natural Gas
0380-0223	MT 310AV	14" (355.6 mm)	10" (254.0 mm)	7" (177.8 mm)	*Acetylene
0380-0227	MT 318A	22.5" (571.5 mm)	18" (457.2 mm)	15" (381.0 mm)	Acetylene
0380-0228	MT 318AV	22.5" (571.5 mm)	18" (457.2 mm)	15" (381.0 mm)	*Acetylene
0380-0225	MT 318N	22.5" (571.5 mm)	18" (457.2 mm)	15" (381.0 mm)	**LP/Natural Gas
0380-0226	MT 318NV	22.5" (571.5 mm)	18" (457.2 mm)	15" (381.0 mm)	**LP/Natural Gas

\*May also be used on other pressurized fuel gases  
 \*\*May also be used on other fuel gases except acetylene  
 Other machine torch models available. Ask for details  
 Gear racks: must be ordered separately

## MT 5

### THREE HOSE



- Cutting capacity - 7" (177.8 mm)
- For use with any fuel gas 2 PSI and above
- Series 1 cutting tips
- Supplied with rack soldered to barrel

Part No.	Model No.	Total Length	Barrel Dia.	Barrel Length	Racking Length	Gas
0380-0208	MT 5	8.5" (215.9 mm)	1.38" (35.1 mm)	5.38" (136.7 mm)	5.38" (136.7 mm)	All

## VCM 200

### Portable Cutting Machine

The versatile VCM 200 is a precision, tractor-type machine that can be used on its own track for straight line cutting and a variety of welding operations. Off track and with a radius rod assembly, the VCM 200 can also be used for circle cutting.

- Large thumb screws for hand tight adjustments
- Dual drive controls & direct speed readout
- Cone disc drive
- Constant speed AC induction motor located on the side opposite the torch for cooler, more efficient operation
- Counter-balanced design allows torch racking distance up to 18" (457.2 mm) from the machine
- Speed constant over wide range of temperatures
- Torch holder designed for 1.38" (35.1 mm) barrel diameter torches

#### PACKAGE DESCRIPTION #1: PACKAGE DESCRIPTION #2:

- |   |   |
|---|---|
| ▪ Cutting machine                         | ▪ Cutting machine                         |
| ▪ MT 210A torch & torch rack              | ▪ Hoses & fittings (for 2 hose operation) |
| ▪ Hoses & fittings (for 2 hose operation) | ▪ 32 pitch pinion torch holder            |
| ▪ Hoses & fittings (for 2 hose operation) | ▪ 3 hose manifold block                   |
| ▪ 32 pitch pinion torch holder            |   |
| ▪ 3 hose manifold block                   |   |

### VCM 200 SERIES ORDERING INFORMATION

Part No.	Model No.	Speed Range/Minute	Pkg. Includes
0200-0220	VCM 200	1-60" (25.4 mm-152.4 cm)	See pkg Description #1
0200-0222	**VCM 200E	1-60" (25.4 mm-152.4 cm)	See pkg Description #1
0200-0224	VCM 200HS	5-120" (127 mm-304.8 cm)	See pkg Description #1
0200-0240	*VCM 200HT	1-60" (25.4 mm-152.4 cm)	See pkg Description #1
0200-0221	VCM 201	1-60" (25.4 mm-152.4 cm)	See pkg Description #2
0200-0225	VCM 201HS	5-120" (127 mm-304.8 cm)	See pkg Description #2
0200-0226	**VCM 200HSE	5-120" (127 mm-304.8 cm)	See pkg Description #1
0200-0241	*VCM 201HT	1-60" (25.4 mm-152.4 cm)	See pkg Description #2

\*Models VCM-200 HT, VCM-201 HT, include heat shield

\*\*Export models available with 220V AC to 110V AC step down transformer

### ACCESSORY ORDERING INFORMATION

Part No.	Description
0212-0018	12' (3.7 m) track section for line cutting
0212-0019	9' (2.7 m) track section for line cutting
0212-0005	6' (1.8 m) track section for line cutting
0252-0040	Radius rod for circle cutting
0253-0042	100" (254.0 cm) radius rod for circle cutting
0252-0136	Dual torch mount assembly
0252-0103	Heat shield



### SPECIFICATIONS

#### STRAIGHT LINE / CIRCLE

- Length increments of 72" (182.9 cm) (track length)
- Circle diameters 4" (101.6 mm) to 96" (243.8 cm)

#### SPEED RANGE

- 1-60"/minute (25.4 mm-152.4 cm/minute)

#### DIMENSIONS

- Length
  - 14.25" (362.0 mm)
- Width
  - 11" (279.4 mm) - machine only
  - 28.5" (723.9 mm) - machine & torch holder
- Height
  - 11.5" (292.1 mm) - top of torch holder
  - 5.5" (139.7 mm) - top of machine

#### WEIGHT

- Machine - 47 lb (21 kg)

## VCM 200 HS

### HIGH SPEED

Has all the convenience and portability features of the standard VCM-200 machine, plus a speed range of 5-120"/min (12.7-304.8 cm/min). The VCM-200HS has a flat mounting deck.

## VCM 200 HT

### HIGH TEMPERATURE

Same convenience, portability features and speed of the VCM-200 (Max. temp. 300°F), plus the addition of a heat shield.

## TORCH HOLDER ADAPTER

### PART NO. 0252-0138

The Torch Holder Adapter is used to adapt the Victor® Thermal Dynamics® SL100 180 Degree plasma torches to the VCM machine. The torch adaptor allows the machine torch to mount on 1 3/8" mounting tube.

Please contact Technical Services on 1-800-426-1888 for more information.

## MODEL BHA 2

Model BHA 2 adjustable head adds flexibility to machine cutting torches by allowing bevel cuts without changing the position of the torch. It can be set at any angle from 0 to 90° on either side of vertical.



- Uses Series 1 cutting tips
- Optional preheat attachment is available for use with the BHA adjustable head attachment. The preheat attachment uses replaceable tip ends

Part No.	Description
0383-0012	BHA 2
0304-0060	Preheating Attachment

Tip nut included (not shown)

## MODEL 591

Model 591 strip cutter for use with machine cutting torches only. It is designed to accept two tips for use with a common torch.



- Uses Series 1 cutting tips
- Adjustable for cutting strips from 1.25" (31.8 mm) to 12" (304.8 mm) wide, and thickness up to 3" (76.2 mm)

Part No.	Description
0383-0000	591 Strip Cutter

## MODEL 497 ROLLER GUIDE

Model 497 roller guide is adaptable to most styles of cutting tips. Fits over the cutting tip shank and is fully adjustable for close, accurate work.



Part No.	Description
0383-0009	497 Roller Guide

## CIRCLE CUTTING ATTACHMENT

Circle Cutting Attachment is easily attached to a cutting torch or cutting attachment. The roller guide is adjustable to various heights and is designed to hold the cutting tip at exact pre-set distance from the work. Cutting range 1.5" (38.1 mm) - 28" (71.1 cm) circle.



Part No.	Description
0383-0006	D 496 Circle Cutting for Series 1 tips

## TEST GAUGES

For use when accurate line pressure is needed.



Part No.	Description
1420-0004	Oxygen, Model PD-10 100# Test, 2" (50.8 mm) Dia. Gauge
1420-0003	Fuel Gas, Model PD-11 30# Test, 2" (50.8 mm) Dia. Gauge

## GEAR RACKS

For use with MT 200 and MT 300 Series cutting torches

(Must be ordered separately)



Part No.	Length	Pitch	Cutting Machine	Actual Length
0319-0054	10" (254.0 mm) Rack Kit	32	MT 210 & MT 310	7.8" (198.1 mm)
0319-0055	18" (457.2 mm) Rack Kit	32	MT 318	14.5" (368.3 mm)

Acetylene.....300, 200, 520, 510	Carbon Dioxide.....320	Nitrogen.....**680, 580
Air (industrial).....590	Helium.....**680, 580	Nitrous Oxide.....326
Air (Breathing).....**347, 346	Hydrogen.....**695, 350	Oxygen.....**701, H577, 540
Argon.....**680, 580	Methane.....**695, 350	Propane.....510
Butane.....510	Natural Gas.....**695, 350	

These CGA connections are designed by Compressed Gas Association, Standard V-1, 6th Edition, 1987.  
For latest standards and connections, contact Compressed Gas Association.

\*Inlet pressure up to 4000 psig  
\*\*Inlet pressure up to 5500 psig

## CGA 200 ACETYLENE (MC)

Part No.	Description
0964-0005	Swivel 1/4"-18 NPT(M) (Nut Included 0.628"-20 NGO RH(F))

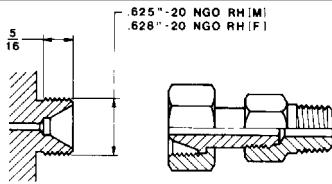

## CGA 300 ACETYLENE (COMMERCIAL)

Part No.	Description
0968-0003	Nut 0.830"-14 NGO RH(F), Brass
0968-0005	Swivel 1/4"-18 NPT, Brass 2" (50.8 mm) Long
0968-0006	Nut 0.830"-14 NGO RH(F), Chrome
0968-0008	Swivel 1/4"-18 NPT, Brass 1.63" (41.4 mm) Long
0968-0014	Swivel 1/4"-18 NPT, Brass 3.25" (82.6 mm) Long
0968-0051	Swivel 1/4"-18 NPT, Chrome 3.25" (82.6 mm) Long

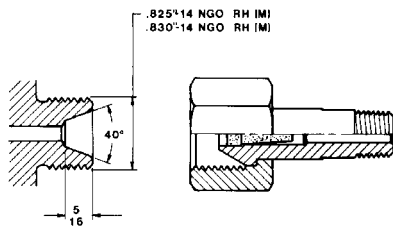

## CGA 320 CARBON DIOXIDE

Part	Description
0985-0004	Swivel 1/4"-18 NPT, Brass 2" (50.8 mm) Long
0985-0008	Swivel 1/4"-18 NPT, Chrome 2" (50.8 mm) Long
0985-0030	Nut 0.830"-14 NGO RH(F), Brass
0985-0031	Nut 0.830"-14 NGO RH(F), Chrome
1408-0065	Washer

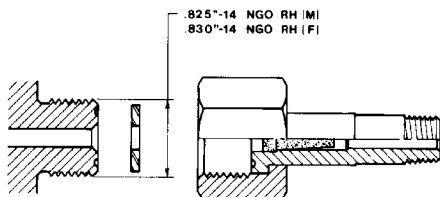

## CGA 326 NITROUS OXIDE

Part No.	Description
0963-0004	Swivel 1/4"-18 NPT, Chrome, 3" (76.2 mm) Long
0963-0016	Nut 0.830"-14 NGO RH(F), Chrome
0963-0015	Nut 0.830"-14 NGO RH(F), Brass
0963-0010	Swivel 1/4"-18 NPT, Brass

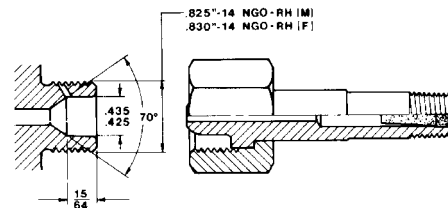

## CGA 346 AIR

Part No.	Description
0972-0010	Swivel 1/4"-18 NPT, Brass, 3" (76.2 mm) Long
0972-0015	Nut 0.830"-14 NGO RH(F), Brass
0972-0016	Nut 0.830"-14 NGO RH(F), Chrome
0972-0017	Swivel 1/4"-18 NPT, Chrome, 3" (76.2 mm) Long

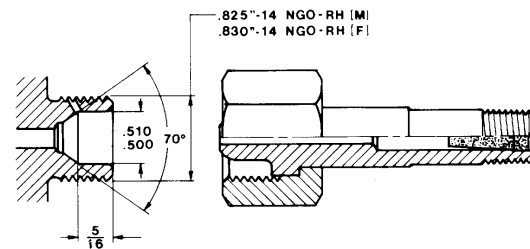

## CGA 347 AIR TO 5500 PSIG

Part No.	Description
0978-0001	Swivel & Nut Assembly, 5/8"-20 Brass, 0.83"-14 NGO RH

## CGA 350 FUEL GAS

Part No.	Description
0983-0003	Nut 0.830"-14 NGO LF(F), Brass
0983-0005	Swivel 1/4"-18 NPT, Brass, 2.25" (57.2 mm) Long
0983-0008	Swivel 1/4"-18 NPT, Brass, 3" (76.2 mm) Long
0983-0013	Nut 0.830"-14 NGO LF(F), Stainless Steel
0983-0014	Swivel 1/4"-18 NPT, Stainless Steel, No filter, 2.25" (57.2 mm) Long
0983-0039	Nut 0.830"-14 NGO LF(F), Chrome
0983-0040	Swivel 1/4"-18 NPT, Chrome, 3" (76.2 mm) Long

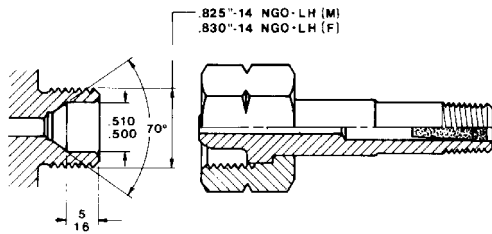

## CGA 510 ACETYLENE (POL)

Part No.	Description
0970-0003	Nut 0.88"-14 NGO LH(M), Brass
0970-0005	Swivel 1/4"-18 NPT, Brass, 3.25" (82.6 mm) Long
0970-0008	Swivel 1/4"-18 NPT, Brass, 4.5" (114.3 mm) Long
0970-0011	Nut 0.88"-14 NGO LH(M), Chrome
0970-0015	Swivel 1/4"-18 NPT, Brass 2.5" (63.5 mm) Long
0970-0017	Swivel 1/4"-18 NPT, Chrome, 3" (76.2 mm) Long

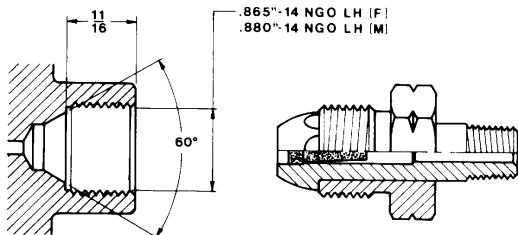

## CGA 520 ACETYLENE (B)

Part No.	Description
0969-0003	Nut 0.9"-18 NGO RH(F)
0969-0005	Swivel 1/4"-18 NPT, 1.75" (44.5 mm) Long

## CGA 540 OXYGEN

Part No.	Description
0967-0033	Swivel 1/4"-18 NPT, Brass, 2.25" (57.2 mm) Long
0967-0034	Swivel 1/4"-18 NPT, Brass, 3" (76.2 mm) Long
0967-0036	Swivel 1/4"-18 NPT, Chrome, 2.25" (57.2 mm) Long
0967-0038	Swivel 1/4"-18 NPT, Brass, 1.5" (38.1 mm) Long
0967-0039	Swivel 3/8"-18 NPT, Brass, 2.25" (57.2 mm) Long
0967-0044	Nut 0.91"-14 NGO RH(F), Brass
0967-0045	Nut 0.91"-14 NGO RH(F), Chrome
0967-0047	Nut 3/8", Brass Std. (Use with 0967-0039)
0967-0105	Nut 0.908"-14 NGO RH(F), Handwheel
0967-0106	Swivel 1/4"-18 NPT, Chrome, 3" (76.2 mm) Long
0967-0110	Swivel 1/4"-18 NPT, Chrome, 3" (76.2 mm) Long (Use with 0967-0105 Medical handwheel)

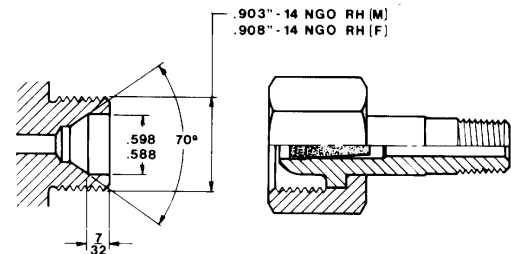

## CGA 580 NITROGEN, ARGON

Part No.	Description
0970-0005	Swivel 1/4"-18 NPT, Brass, 3.25" (82.6) Long
0970-0008	Swivel 1/4"-18 NPT, Brass, 4.5" (114.3 mm) Long
0970-0015	Swivel 1/4"-18 NPT, Brass, 2.25" (57.2 mm) Long
0970-0017	Swivel 1/4"-18 NPT, Chrome, 3" (76.2 mm) Long
0973-0003	Nut 0.96"-14 NGO RH(M), Brass
0973-0004	Nut 0.96"-14 NGO RH(M), Stainless Steel
0973-0005	Nut 0.96"-14 NGO RH(M), Chrome

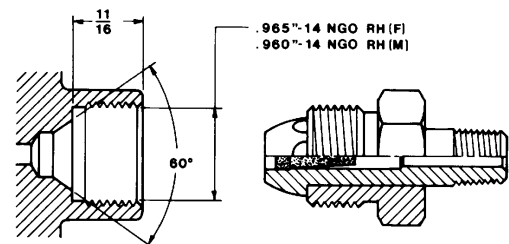

## CGA 590 AIR

Part No.	Description
0970-0005	Swivel 1/4" NPT, Brass, 3.25" (82.6 mm) Long
0970-0008	Swivel 1/4" NPT, Brass, 4.5" (114.3 mm) Long
0970-0015	Swivel 1/4" NPT, Brass, 2.25" (57.2 mm) Long
0970-0017	Swivel 1/4"-18 NPT, Chrome, 3" (76.2 mm) Long
0974-0003	Nut 0.83"-14 NGO RH(F), Chrome
0974-0010	Nut 0.83"-14 NGO RH(F), Chrome

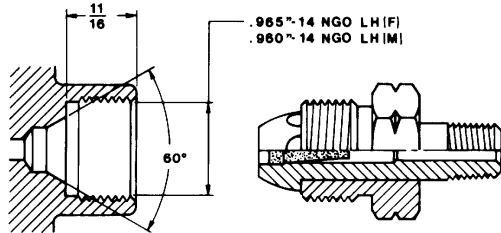

## CGA 677 INERT GASES TO 7500 PSIG

Part No.	Description
0958-0008	Nut, 1.03"-14 NGO LH(F)

## CGA 695 FUEL GASES TO 5500 PSIG

Part No.	Description
0959-0003	Nut, 10.88"-14 NGO RH(M), Chrome

## CGA 660 CORROSIVE

Part No.	Description
0995-0017	Swivel 1/4"-18 NPT, Stainless Steel, No filter, 2.5" (63.5 mm) Long
1408-0024	Washer

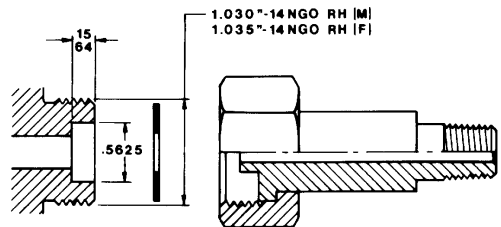

## CGA 680

NITROGEN, ARGON TO 5500 PSIG

Part No.	Description
0958-0003	Nut, 1.04"-14 NGO RH(M)

## CGA 701 OXYGEN TO 5500 PSIG

Part No.	Description
0988-0003	Nut, 1.11"-14 NGO RH(F)

## 992 BRITISH OXYGEN & INERT GAS

Part No.	Description
0970-0005	Swivel 1/4"-18 NPT, Brass, 3.25" (82.6 mm) Long
0970-0008	Swivel 1/4"-18 NPT, Brass, 4.5" (114.3 mm) Long
0970-0015	Swivel 1/4"-18 NPT, Brass, 2.25" (57.2 mm) Long
0992-0003	Nut 0.9"-14 NGO RH(M), Brass

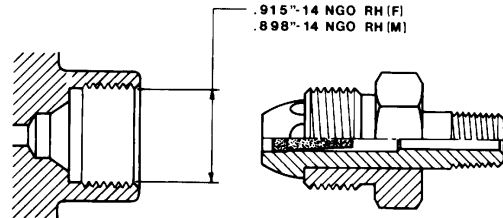

## 993 BRITISH FUEL GAS

Part No.	Description
0993-0003	Nut 0.898"-14 NGO LH(M), Brass
0970-0005	Swivel 1/4"-18 NPT, Brass, 3.25" (82.6 mm) Long
0970-0008	Swivel 1/4"-18 NPT, Brass, 4.5" (114.3 mm) Long
0970-0015	Swivel 1/4"-18 NPT, Brass, 2.25" (57.2 mm) Long

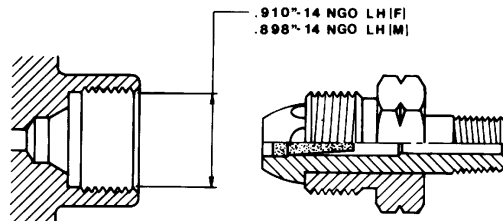



## VICTOR 996

### MANIFOLD OXYGEN & INERT GAS

Part No.	Description
0996-0004	Nut 1-11.5" NPS RH(F), Brass
0996-0005	Swivel 1/2"-14 NPT, Brass, No Filter 2.5" (63.5 mm) Long

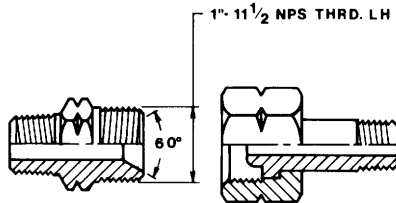

## VICTOR 997 MANIFOLD FUEL GAS

Part No.	Description
0997-0004	Nut 1"-11.5 NPS LH(F), Brass
0996-0005	Swivel 1/2"-14 NPT, Brass, No Filter 2.5" (63.5 mm) Long
0996-0031	Swivel 1/4"-18 NPT, Brass, No Filter 2.5" (63.5 mm) Long, 0.13" Orifice, Hydrogen Only
0996-0032	Swivel 1/2"-14 NPT, Brass, No Filter 2.5" (63.5 mm) Long, 0.13" Orifice, Hydrogen Only

## CGA 024 STATION OXYGEN

Part No.	Description
0969-0003	Nut 0.9"-18 NGO RH(F)
0969-0005	Swivel 1/4"-18 NPT, 1.75" (44.5 mm) Long
0952-0000	Swivel 1/4"-18 NPT, Brass, 2" (50.8 mm) Long (350 Series)

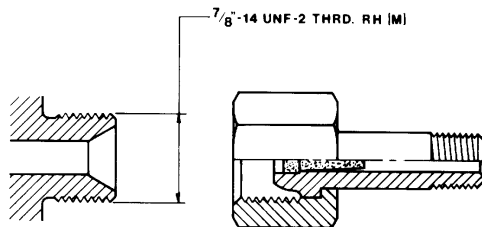

## CGA 025 STATION FUEL GAS

Part No.	Description
0966-0003	Nut 7/8"-14 UNF LH(F), Brass
0965-0004	Swivel 1/4"-18 NPT, Brass, 2" (50.8 mm) Long
0952-0000	Swivel 1/4"-18 NPT, Brass, 2" (50.8 mm) Long (350 Series)

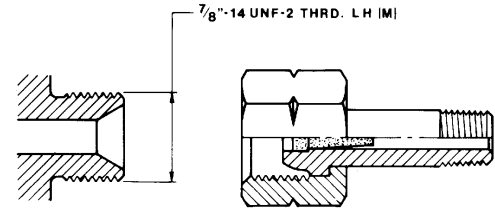

## CGA 034 STATION INERT GAS

Part No.	Description
0956-0000	Nut 7/8"-14 UNF RH(M), Brass
0952-0001	Swivel 1/4"-18 NPT, RH(M) Brass, 2.5" (63.5 mm) Long

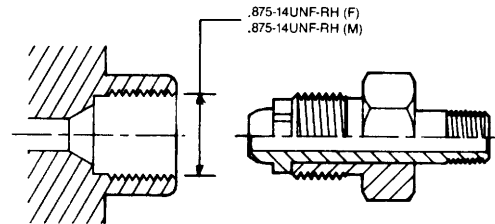

CGA

**LIMITED WARRANTY:** ESAB warrants that its products will be free of defects in workmanship or material. Should any failure to conform to this warranty appear within the time period applicable to the ESAB products as stated below, ESAB shall, upon notification thereof and substantiation that the product has been stored, installed, operated, and maintained in accordance with ESAB's specifications, instructions, recommendations and recognized standard industry practice, and not subject to abuse, misuse, neglect, alteration, accident, improper care and/or maintenance including lack of lubrication and protection from the elements, use of non ESAB genuine parts including consumables; will correct such defects by suitable repair or replacement, at ESAB's sole option, of any components or parts of the product determined by ESAB to be defective.

**THIS WARRANTY IS EXCLUSIVE AND IS IN LIEU OF ANY WARRANTY OF MERCHANTABILITY OR FITNESS FOR A PARTICULAR PURPOSE.**

**LIMITATION OF LIABILITY:** ESAB shall not under any circumstances be liable for special or consequential damages, such as, but not limited to, damage or loss of purchased or replacement goods, or claims of customers of distributor (hereinafter "Purchaser") for service interruption.

The remedies of the Purchaser set forth herein are exclusive and the liability of ESAB with respect to any contract, or anything done in connection therewith such as the performance or breach thereof, or from the manufacture, sale, delivery, resale, or use of any goods covered by or furnished by ESAB whether arising out of contract, negligence, strict tort, or under any warranty, or otherwise, shall not, except as expressly provided herein, exceed the price of the goods upon which such liability is based.

**THIS WARRANTY BECOMES INVALID IF REPLACEMENT PARTS OR ACCESSORIES ARE USED WHICH MAY IMPAIR THE SAFETY OR PERFORMANCE OF ANY ESAB PRODUCT.**

**THIS WARRANTY IS INVALID IF THE PRODUCT IS SOLD BY NON-AUTHORIZED PERSONS.**

The warranty is effective for the time stated below beginning on the date that the authorized distributor delivers the products to the Purchaser. Notwithstanding the foregoing, in no event shall the warranty period extend more than the time stated plus 1 year from the date ESAB delivered the product to the authorized distributor.

**5 YEARS PARTS / NO LABOR**

Victor® (Exceptions noted below)  
Victor® Slimlite Medical

**2 YEARS PARTS / NO LABOR**

CutSkill®, Oxygen Conservers, Victor® VSP,  
HP&I Brass Regulators/Manifolds  
All other Victor® Medical product

**1 YEAR PARTS / NO LABOR**

Steel Cylinders, Cutting Machine Motors (i.e. VCM 200)  
HP&I Stainless Regulators/Manifolds (non corrosive gas)  
Parts in Rental Applications  
(from the date sold by seller to authorized distributor)

**90 DAYS PARTS / NO LABOR**

HP&I Corrosive Gas Regulators/Manifolds

**ESAB limited warranty shall not apply to: Consumable Parts for MIG, TIG, Plasma welding, Plasma cutting and Oxyfuel torches, O-rings, fuses, filters or other parts that fail due to normal wear.**

\* Warranty repairs or replacement claims under this limited warranty must be submitted by an authorized ESAB repair facility within thirty (30) days of the repair.

\* No employee, agent, or representative of ESAB is authorized to change this warranty in any way or grant any other warranty, and ESAB shall not be bound by any such attempt. Correction of non-conformities, in the manner and time provided herein, constitutes fulfillment of ESAB's obligations to purchaser with respect to the product.

\* This warranty is void, and seller bears no liability hereunder, if purchaser used replacement parts or accessories which, in ESAB's sole judgment, impaired the safety or performance of any ESAB product. Purchaser's rights under this warranty are void if the product is sold to purchaser by unauthorized persons.



**ISO 9001  
REGISTERED FIRM**

The Quality System of ESAB  
at our Denton, Roanoke,  
West Lebanon and Hermosillo  
locations is registered to meet  
the requirements of ISO 9001

---

U.S. Customer Care: 800-426-1888 / FAX 800-535-0557 • Canada Customer Care: 905-827-4515 / FAX 800-588-1714  
International Customer Care: 940-381-1212 / FAX 940-483-8178 • CIGWELD Customer Care: 1 300-654-674 / FAX 61-3-9474-7391

---